

Sandwich Collection

Table



Sandwich, designed by Untaller studio, is a collection of tables of great versatility destined to the world of restaurant spaces and coffee shops. Sandwich is a robust and sober table where its “double” column gives a distinctive character.

The column, which characterizes the Sandwich table, offers the option of being customized applying distinct finishes of wood in combination with the base or the top.

Sandwich Collection

Top / Sobre

Wide range of tabletops with different dimensions and finishes.

Gran variedad de sobres de mesa con diferentes dimensiones y acabados.



Column / Columna

Metallic steel column powder coated in RAL colours. The column can be finished in natural or lacquered ash wood.

Columna metálica en acero pintado en polvo con colores RAL. Opcional revestir la columna con madera de fresno acabado natural o lacado.

Base

The square or circular base with powder coated RAL colours steel metallic columns.

La base cuadrada o circular con columnas metálicas en acero pintado en polvo con colores RAL.

Collection Models

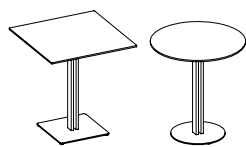

Sandwich dining table medium

H75 / Top: Ø 80-90 / 70x70 / 80x80

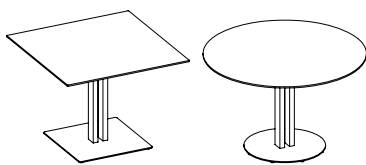

Sandwich table large

H75 / Top: Ø 110-120 / 90x90 / 100x100

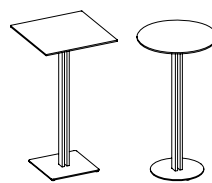

Sandwich bar table

H110 / Top: Ø 70-80 / 60x60 / 70x70

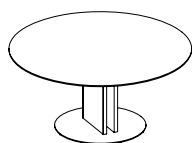

Sandwich XL round table

H75 / Top: Ø 180 / 150x150

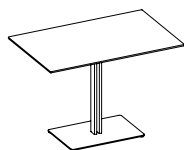

Sandwich rectangular table large

H75 / Top: 100x80

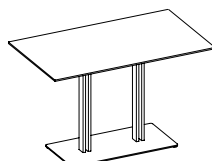

Sandwich rectangular double column table large

H75 / Top: 140x100

Sandwich medium table



Table with a square or circular base, 6 x 3 cm metallic section columns in powder painted steel. Adjustable levelers. Optional veneer finish on the column.

Ref.

351-01 Sandwich square dining table medium

with a square base and metallic columns. Ø 90 or 80 x 80 cm maximum recommended table top.

351-02 Sandwich square dining table medium

with a square base and metallic columns with veneer finish. Ø 90 or 80 x 80 cm maximum recommended table top.

352-01 Sandwich round dining table medium

with a circular base and metallic columns. Ø 80 or 70 x 70 cm maximum recommended table top.

352-02 Sandwich round dining table medium

with a circular base and metallic columns with veneer finish. Ø 80 or 70 x 70 cm maximum recommended table top.

Dimension

ø90 / 80 x 80

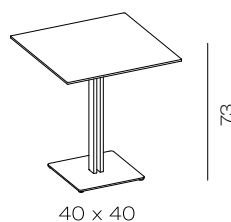

Ref. 351

Weight 20 kg/u
(+3 kg with veneer finish)

Volumetric Packaging
1u. 45 x 45 x 75 cm

ø80 / 70x70

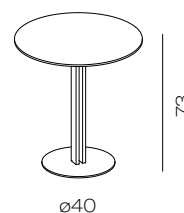

Ref. 352

Weight 18.5 kg/u
(+3 kg with veneer finish)

Volumetric Packaging
1u. 45 x 45 x 75 cm

Floor protectors

Felt glides for delicate floors
Glides for hard floor surfaces.

Sandwich bar table



High table with a square or circular base, 6 x 3 cm metallic section columns in powder painted steel. Adjustable levelers. Optional veneer finish on the column.

Ref.

353-01 Sandwich square bar table

with square base and metallic columns. Ø 80 or 70 x 70 cm maximum recommended table top

353-02 Sandwich square bar table

with square base and metallic columns with veneer finish. Ø 80 or 70 x 70 cm maximum recommended table top

354-01 Sandwich round bar table

with a circular base and metallic columns. Ø 70 or 60 x 60 cm maximum recommended table top

354-02 Sandwich round bar table

with a circular base and metallic columns with veneer finish. Ø 70 or 60 x 60 cm maximum recommended table top

Dimension

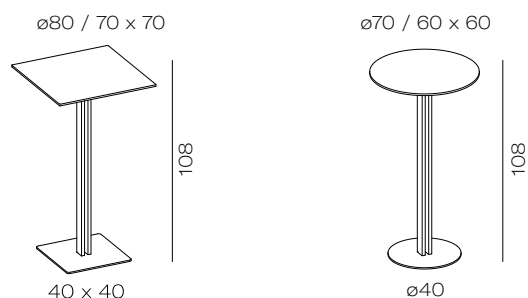

Ref. 353

Weight 23 kg/u
(+4.5 kg with veneer finish)

Volumetric Packaging
1u. 45 x 45 x 110 cm

Ref. 354

Weight 21.5 kg/u
(+4.5 kg with veneer finish)

Volumetric Packaging
1u. 45 x 45 x 110 cm

Floor protectors

Felt glides for delicate floors
Glides for hard floor surfaces.

Sandwich large table



Table with a square base, 8 x 5 cm steel section columns in powder painted steel. Adjustable levelers. Optional veneer finish on the column.

Ref.

355-01 Sandwich square dining table large
with a square base and metallic columns with veneer finish. Ø 120 or 100 x 100 cm maximum recommended table top.

355-02 Sandwich square dining table large
with a square base and metallic columns with veneer finish. Ø 120 or 100 x 100 cm maximum recommended table top.

356-01 Sandwich round dining table large
with a circular base and metallic columns. Ø 110 or 90 x 90 cm maximum recommended table top.

356-02 Sandwich round dining table large
with a circular base and metallic columns with veneer finish. Ø 110 or 90 x 90 cm maximum recommended table top.

Dimension

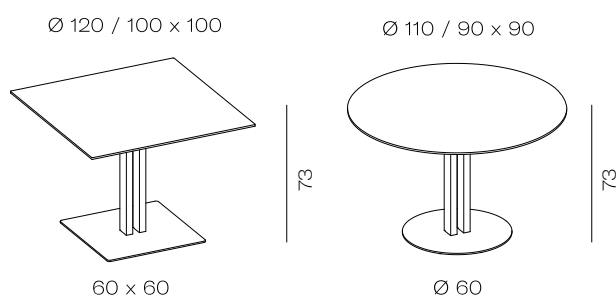

Ref. 355

Weight 40 kg/u
(+5 kg with veneer finish)

Volumetric Packaging
1u. 65 x 65 x 75 cm

Ref. 356

Weight 36 kg/u
(+5 kg with veneer finish)

Volumetric Packaging
1u. 65 x 65 x 75 cm

Floor protectors

Felt glides for delicate floors
Glides for hard floor surfaces.

Sandwich rectangular large table



Table with a rectangular base, with one or two double 6 x 3 cm metallic section columns in powder painted steel. Adjustable levelers. Optional veneer finish on the column.

Ref.

357-01 Sandwich rectangular dining table large

with a rectangular base and metallic columns.
100 x 80 cm maximum recommended table top.

357-02 Sandwich rectangular dining table large

with a rectangular base and metallic columns with veneer finish. 100 x 80 cm maximum recommended table top.

358-01 Sandwich rectangular double column dining table large

with a rectangular base and metallic columns.
140 x 100 cm maximum recommended table top.

358-02 Sandwich rectangular double column dining table large

with a rectangular base and metallic columns with veneer finish. 140 x 100 cm maximum recommended table top.

Dimension

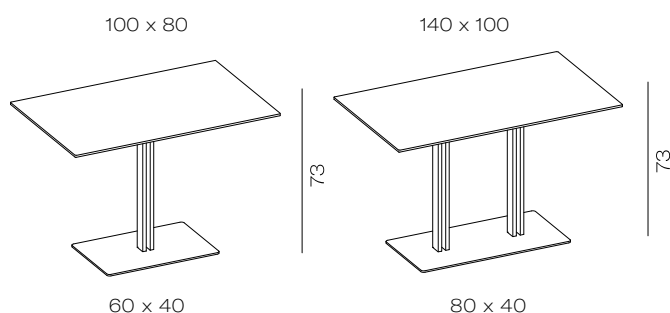

Ref. 357

Weight 25 kg/u
(+3 kg with veneer finish)

Volumetric Packaging
1u. 65 x 45 x 75 cm

Ref. 358

Weight 50 kg/u
(+3 kg with veneer finish)

Volumetric Packaging
1u. 85 x 65 x 75 cm

Floor protectors

Felt glides for delicate floors
Glides for hard floor surfaces.

Sandwich XL round table



Table with a circular base and metallic columns in powder painted steel with veneer finish. Adjustable levelers.

Ref.

359-01 Sandwich dining table XL

with a round base and metallic structure with veneer finish. Ø 180 or 150 x 150 cm maximum recommended table top.

Dimension

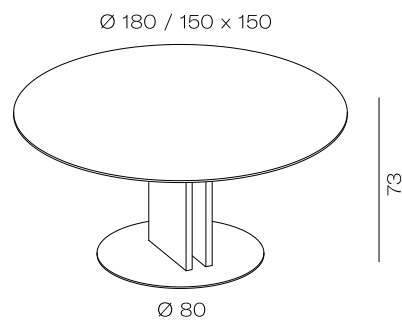

Weight 60 kg/u

Volumetric Packaging
1u. 20 x 80 x 80 cm

Wooden Finishes

Acabados madera

Natural varnished wood /
Madera natural embarnizada



Ash / Fresno

Dyed ash wood
Fresno teñido



Pearl 59

Vanilla 41

Amber 49

Rustic 24

Cherry 55

Chestnut 35

Mocca 37

Cocoa 39

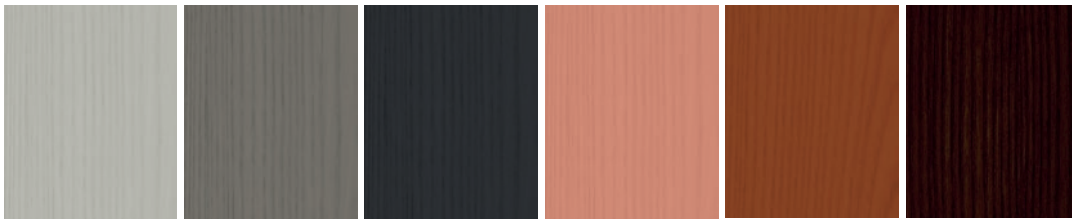

Stone 43

Graphite 45

Onyx 34

Coral 44

Cooper 46

Wine 90



Linen 42

Mint 50

Olive 47

Nori 38

Aqua 48

Indigo 51

Lacquered ash open pore /
Fresno lacado poro abierto



RAL 1027

RAL 8004

RAL 6005

RAL 5020

+

Other RAL colours are available on request.
Please contact our sales team.

Se puede aplicar otros colores RAL bajo demanda.
Consultar con el equipo comercial.

Varnish applied on natural, dyed or lacquered wood (Open Pore)
EM extra matt / AN satin

Mineral Finishes Dekton

Group 0



Kairos Aeris Lunar Eter

Group 1



Nacre Kreta Kira Sirius

Group 2

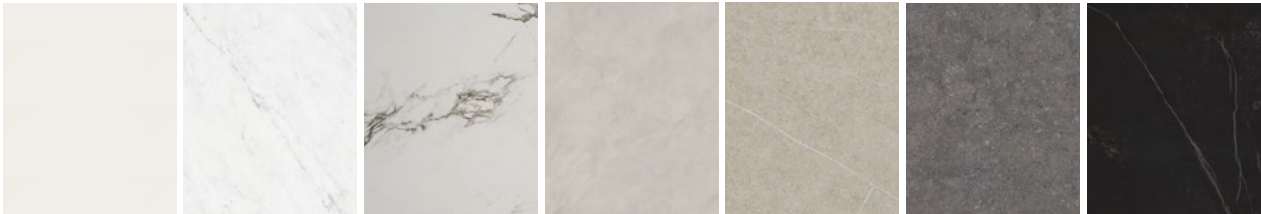

Zenith Marina Avorio Argentium Adia Grafite Kelya

Group 4

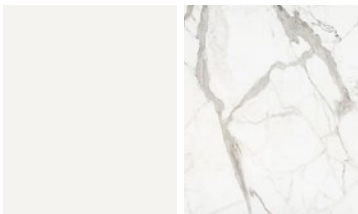

Uyuni Daze

Mineral Finishes

Silestone

Group 1

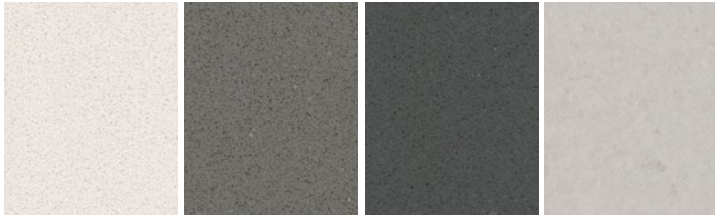

White Storm 14

Gris Expo

Marengo

Motion Grey

Group 2

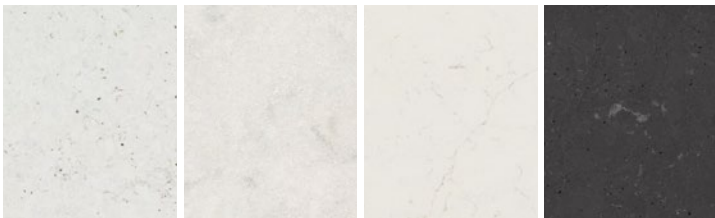

Lime Delight

Lagoon

Persian White

Cinder Craze

Group 3

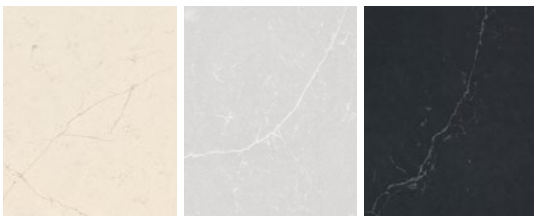

Et. Marfil

Desert Silver

Charcoal
Soapstone

Group 4



Faro White

Posidonia Green

Arcilla Red

Pearl Jasmine

Melamine - Laminate

Egger

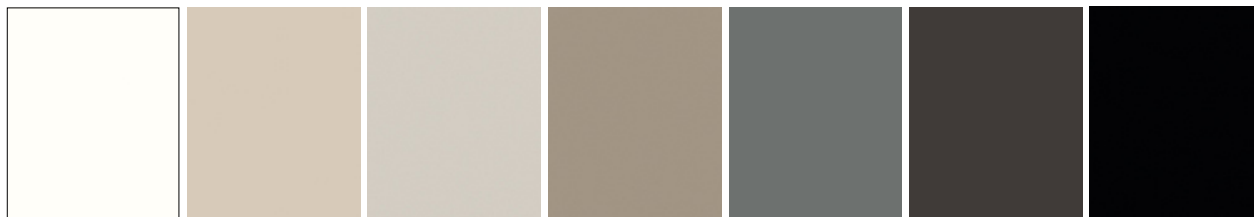

Blanco alpino
W1100 ST9

Gris cashemira
U702 ST9

Gris claro
U708 ST9

Gris arcilla
U727 ST9

Gris macadán
U732 ST9

Gris grafito
U961 ST9

Negro
U999 ST9

Metal Finishes

Acabados metal

Powder Coated RAL Textured

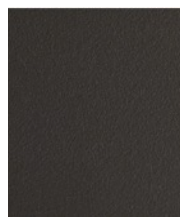

RAL
9004

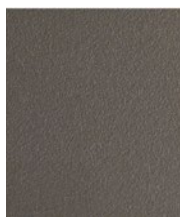

RAL
7039



RAL
7044



RAL
1013

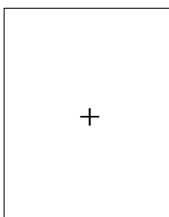

Other RAL colours are available on request.
Please contact our sales team.

Se puede aplicar otros colores RAL bajo demanda.
Consultar con el equipo comercial.

Matt

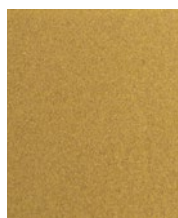

Brass