

The background of the entire page is a light beige or tan color with a subtle, intricate topographic map pattern. The map consists of numerous thin, dark lines that form irregular, concentric shapes, suggesting contour lines on a terrain map. The lines are more densely packed in some areas and more spread out in others, creating a sense of depth and texture.

VERGÉS

2020

New
Collections

Company

Origen P.4

Collections

ABC Collection P.12

Bernardes Collection P.30

Bogart Collection P.42

Cistell Collection P.56

Dula Collection P.74

Glöwr Collection P.96

Kimmi Collection P.126

Mim Collection P.138

Naoshima Collection P.150

Sandwich Collection P.168

Product information

ABC Information P.186

Bernardes Information P.190

Bogart Information P.192

Cistell Information P.194

Dula Information P.196

Glöwr Information P.206

Kimmi Information P.208

Mim Information P.218

Naoshima Information P.222

Sandwich Information P.224

General finishes P.228





Las sillas y muebles Vergés son el resultado de la conjunción de experiencia, vocación, calidad y diseño. Producto de una empresa familiar nacida en Tortellà, una localidad de la Alta Garrotxa, sigue desarrollando su actividad en el mismo lugar desde su fundación hace cincuenta años. Una permanencia que ayuda a entender la filosofía de la empresa, su forma de ser y su manera de trabajar.

Vergés chairs and furniture are the result of a combination of experience, vocation, quality and design. A family company born in Tortellà, a town in Alta Garrotxa, Vergés has been carrying out its business in the same location for 50 years. Such continuance provides insight into the company's philosophy, personality and way of working.

Fundada en 1970 por el matrimonio Vergés Picart, la empresa comparte las raíces de la comarca en que está radicada. La Garrotxa, en la provincia de Girona, a medio camino entre el Mediterráneo y los Pirineos, es un territorio rural privilegiado, único, apartado de las grandes ciudades. Una orografía de origen volcánico que ha condicionado el paisaje y la vegetación, con espectaculares bosques de hayas que crecen sobre coladas de lava enfriadas hace miles de años.

En cualquier estación del año, la Garrotxa es un estallido de colores. Todos los matices, del ocre al negro, del verde al rojizo, configuran un paisaje visual que marca profundamente a la gente de la comarca.

Paleta de colores espléndida y madera de haya. Inspiración más que sobrada para un fabricante de mobiliario. En sus inicios, Vergés era un pequeño taller dedicado a la fabricación de sillas artesanales de boga, algo muy ligado al territorio. Desde esos orígenes, su producción ha evolucionado junto al crecimiento de la empresa y siempre con una mirada hacia el norte a aquellos países con una sólida tradición en el diseño y el mobiliario de calidad.

Una evolución imprescindible para mantenerse en un mercado cada vez más exigente que pasa por emplear las últimas tecnologías, optimizar los recursos y convertir el taller original en una moderna y dinámica factoría con alrededor de 50 empleados. Al mismo tiempo se ha llevado a cabo un relevo generacional y, actualmente, son Esteve y Joan, hijos del matrimonio fundador, quienes se hallan impulsando la nueva etapa de la empresa.

Pese a esta transformación, Vergés no quiere renunciar a sus orígenes, al oficio, la tradición y la atención por el detalle. Unos principios reflejados en las colecciones actuales, que establecen un diálogo entre lo artesanal y lo moderno, donde la innovación va de la mano de la calidad en los materiales, el diseño y los buenos acabados.

Founded in 1970 by the Vergés Picart couple, the company shares its roots with the region in which it's located. In the province of Girona, La Garrotxa is found halfway between the Mediterranean and the Pyrenees. It is a privileged and unique rural region removed from large cities. Its volcanic orography has conditioned the landscape and vegetation, endowing it with spectacular beech tree forests that grow on tracks of lava cooled down thousands of years ago.

At any time of year, La Garrotxa is an explosion of colour. From ochre to black, and green to copper, each nuance contributes to a visual landscape that leaves a deep mark on the region's people.

A splendid palette of colours and beechwood. More than enough inspiration for a furniture manufacturer. At its start, Vergés was a small workshop dedicated to the production of artisanal wicker chairs, as was the tradition in the region. From those origins, its production has evolved as business has grown, always with a view toward northern countries with a strong tradition in design and quality furniture.

Such an evolution has been essential to keeping up with an ever-more demanding market and has meant using the latest technology, optimizing resources and turning the original workshop into a modern and dynamic factory employing approximately 50 people. At the same time, there was a generational turnover and, today, Esteve and Joan, the founders' children, are driving this new stage of the company.

Despite this transformation, Vergés refuses to give up its roots, vocation, tradition and attention to detail. These principles are reflected in its current collections, which establish a dialogue between artisanship and modernity, where innovation goes hand in hand with quality material, design and good finishes.



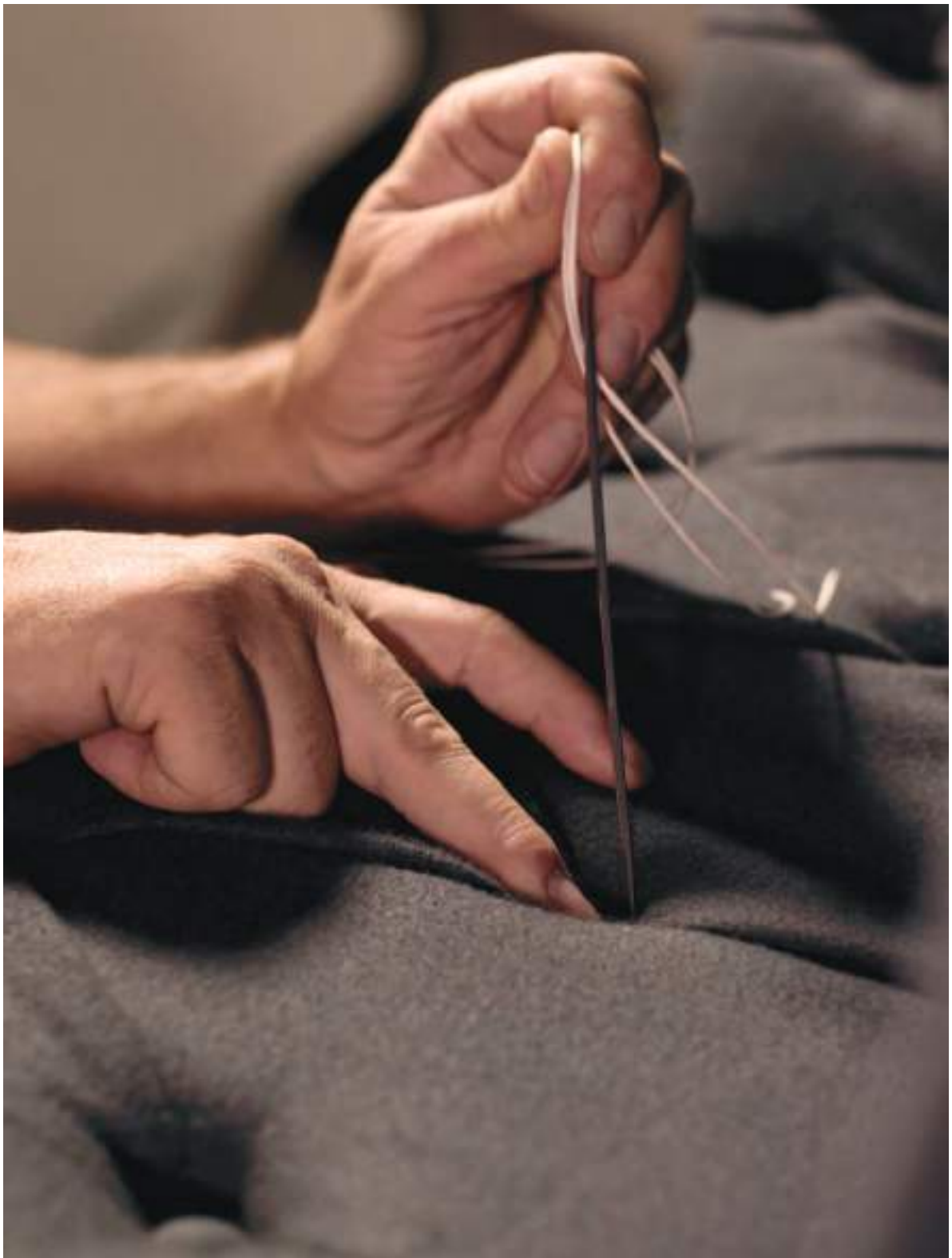

Hoy, las sillas y muebles Vergés se han convertido en un referente para arquitectos e interioristas que buscan colecciones de mobiliario contemporáneo y de alta calidad para la hostelería y espacios públicos.

El mobiliario actual de Vergés ha sido diseñado y desarrollado por figuras relevantes del diseño y elaborado con sumo cuidado en los talleres de la propia empresa, produciendo unos muebles que aseguran un óptimo resultado en la imagen visual de cualquier instalación.

Carácter, resistencia, cumplimiento de los plazos de entrega y un servicio posventa que se ajusta a las exigencias de cualquier proyecto contract.

Además, como apasionados del interiorismo y el diseño, Vergés entiende que cada proyecto es un mundo en sí mismo y que, por ese motivo, la adaptabilidad es otra de las claves para ser apreciados hoy en día. Esto se traduce en la capacidad de amoldarse a las necesidades de todo cliente, ofreciéndole la personalización de los acabados de cualquier modelo del catálogo con tejidos de alta calidad y una amplia paleta de materiales y colores.

Today, Vergés chairs and furniture represent a benchmark for architects and interior designers in search of contemporary and high-quality furniture collections for hotels, restaurants and public spaces.

The Vergés furniture of today was designed and developed by renowned design personalities and manufactured with the utmost care at the company's own workshops, yielding furniture that ensures an optimal result in the visuals of any installation.

Character, endurance, on-time deliveries and after-sales servicing adapted to the demands of any project contract.

And with its passion for interior design, Vergés understands that each project is a world of its own, making adaptability a key to success in today's world. This translates to the ability to adapt to the needs of any client, offering customized finishes for any model from the catalogue, high-quality fabrics and a wide range of materials and colours.





1

2

1. ABC table metal base code 974 – Base: powder coated RAL 7044 matte.
/ ABC wooden top code 977 Ø 70 cm – Top: ash veneer lacquered RAL 7044 PO AN.
2. ABC chair code 970 – Frame: powder coated RAL 7044 matte / Seat and backrest:
beech veneer dyied Grey 74 EM / Seat and backrest: upholstered Gabriel Note 68156.

ABC Collection

– by Lázaro
Rosa-Violán

En el mundo del lenguaje, ABC representa el abecedario, también nos acerca al mundo de las aulas y los colegios, en el que Lázaro Rosa-Violán se ha inspirado para crear esta colección de sillas y mesas elementales. Las sillas ABC son ligeras y equilibradas, combinan un gran confort con la resistencia y durabilidad, y evocan un cierto carácter de atemporalidad.

In the world of language, ABC represents the alphabet and brings us closer to schools and classrooms, where Lázaro Rosa-Violán found the inspiration to create this collection of elemental chairs and tables. ABC chairs are lightweight and balanced, combining great comfort with strength and durability. They evoke a certain timelessness.



P:14 P:15 ABC armrest chair code 971 / Frame: powder coated RAL 9004 matte / Seat and backrest: beech veneer dyed Grey 79 EM / Seat: upholstered Gabriel Harmony 1113.





ABC chair code 972 / Frame: powder coated RAL 5004 satin / Seat and backrest: ash veneer lacquered RAL 5004 PO AN / Legs: ash solid wood lacquered RAL 5004 PO AN / Seat: upholstered Gabriel Note 66144.

1. ABC armrest chair code 973 / Frame: powder coated RAL 7030 matte / Seat and backrest: ash veneer natural varnished EM / Legs: ash solid wood natural varnished EM / Seat: upholstered Gabriel Note 61147.
2. ABC chair code 972 / Frame: powder coated RAL 6013 textured / Seat and backrest: ash veneer natural varnished EM / Legs: ash solid wood natural varnished EM / Seat: upholstered Gabriel Harmony 4104.

1



2



La colección ofrece una amplia gama lo cual la hace muy versátil para diferentes entornos. ABC está formada por cuatro modelos de sillas (con o sin brazos, apilables con patas metálicas o en madera maciza) y dos mesas abatibles, de sobres redondos o cuadrados, con diferentes acabados.
+ Info P.148

The collection offers a wide variety, making it very versatile and apt for use in different settings. ABC comprises four chair models (with or without arms, stackable, with metal or solid wood) and two drop-leaf tables, with round or square tabletops and different finishes.
+ Info P.148



1. ABC chair code 970 / Frame: powder coated RAL 7044 matte / Seat and backrest: beech veneer dyed Grey 74 EM / Seat and backrest: upholstered Gabriel Note 68156.
2. ABC table metal base code 974 – Base: powder coated RAL 7044 matte.
/ ABC wooden top code 977 Ø 70 cm – Top: ash veneer lacquered RAL 7044 PO AN.



2



ABC Collection



2

P.20 to P.23 1. ABC table metal base code 974 – Base: powder coated RAL 1013 matte. / ABC wooden top code 977 Ø 60 cm – Top: ash veneer lacquered RAL 1027 PO AN.
2. ABC armrest chair code 973 / Frame: powder coated RAL 1027 satin / Seat and backrest: ash veneer lacquered RAL 1027 PO AN / Legs: ash solid wood lacquered RAL 1027 PO AN / Seat and backrest: upholstered Gabriel Note 62041.

2



ABC Collection







P.24 P.25 ABC armrest chair code 973 / Frame: powder coated RAL 7030 matte
/ Seat and backrest: ash veneer natural varnished EM / Legs: ash solid wood natural varnished EM
/ Seat: upholstered Gabriel Note 61147.



1



2

1. Bernardes lounge code 293 / Frame: beech solid wood dyied White 93 EM
/ Backrest: cane mesh dyied White 93 EM / Seat: upholstered Gabriel Mood 1105.
2. Bernardes lounge code 293 / Frame: beech solid wood dyied Pink 32 EM
/ Backrest: cane mesh dyied Pink 32 EM / Seat: upholstered leather Penelopegi Nuvola P0151.

Bernardes Collection

– by Andreu
Carulla

La colección Bernardes, creada por Andreu Carulla, pretende capturar la imagen de austeridad y discreción que asociamos a los conventos románicos medievales. El resultado de esta sugerente idea es unir en la colección la tradición, la atemporalidad y la sobriedad de aquello que debe soportar el paso del tiempo.

Bernardes collection, created by Andreu Carulla, aims to capture the image of austerity and discretion that we associate with medieval Roman convents. As a result of this suggestive idea, the collection combines tradition, timelessness and the sobriety of that which must tolerate the passage of time.



P.68 P.69 Bernardes chair code 290 / Frame: beech solid wood dyied Grey 74 EM / Backrest: cane mesh dyied White 13 EM / Seat: upholstered Gabriel Mood 1104.



1. Bernardes lounge code 293 / Frame: beech solid wood dyied White 93 EM
/ Backrest: cane mesh dyied White 93 EM / Seat: upholstered Gabriel Mood 1105.
2. Bernardes chair code 290 / Frame: beech solid wood dyied Grey 74 EM
/ Backrest: cane mesh dyied Grey 74 EM / Seat: upholstered Gabriel Mood 1104.
3. Bernardes chair code 290 / Frame: beech solid wood dyied White 13 EM
/ Backrest: cane mesh dyied White 13 EM / Seat: upholstered Gabriel Mood 3101.



1

2

Bernardes, confortables y sofisticadas, en sus versiones de silla, sillón y banco, combinan la madera de haya, la tela o cuero tapizados y la cestería de ratán artesanal, unos materiales que las hacen robustas y duraderas.

+ Info P.164

Bernardes, comfortable and sophisticated in its chair, armchair and bench versions, combine beechwood, upholstered fabric or leather, and artisan wickerwork to make robust and long-lasting pieces.

+ Info P.164



3



1



2



1. Bernardes lounge code 293 / Frame: beech solid wood dyied Pink 32 EM
/ Backrest: cane mesh dyied Pink 32 EM / Seat: upholstered leather Penelopeogí Nuvola P0151.
2. Bernardes bench code 292 / Frame: beech solid wood dyied White 13 EM
/ Backrest: cane mesh dyied White 13 EM / Seat: upholstered Gabriel Mood 1105.





P.74 P.75 Bernardes lounge code 293 / Frame: beech solid wood dyied Blue 54 EM
/ Backrest: cane mesh dyied Blue 54 EM / Seat: upholstered Spradling Dolce Indigo 6725.



1

1. Bernardes bench code 292 / Frame: beech solid wood dyied White 13 EM
/ Backrest: cane mesh dyied White 13 EM / Seat: upholstered Gabriel Mood 1105.
2. Bernardes lounge code 293 / Frame: beech solid wood dyied White 13 EM
/ Backrest: cane mesh dyied White 13 EM / Seat: upholstered Gabriel Mood 1105.

Bernardes Collection



2

Bogart armchair code 501 / Frame: natural ash PO Extra Mate / Seat: double wave, natural paper cord



Bogart Collection

– by Manel
Molina Studio

La colección Bogart diseñada por Estudi Manel Molina propone una relectura en clave contemporánea de la tradicional silla de enea y rinde homenaje a la tipología con la que Vergés empezó su trayectoria en la década de los años 70.

Madera, enea, artesanía, tradición son materiales y conceptos que juntos definen el arquetipo de la silla mediterránea por excelencia, una pieza icónica presente en nuestra memoria colectiva, una silla auténtica y cercana.

Bogart collection designed by Manel Molina Studio is a contemporary rereading of the traditional enea chair, which pays homage to the typology used in the beginning of Vergés career in the 1970s. Wood, enea, artisanal, tradition... are materials and concepts that together define the archetype of the Mediterranean chair for excellence, an iconic piece present in our collective memory, an authentic and close chair.



P44 P.45 Bogart armchair code 501 / Frame: Lacquered ash RAL 7044 PO Extra Mate / Seat: quadruple weave, natural paper cord



Según su contexto de uso está disponible en diversos materiales y acabados.

El asiento de cuerda de papel es fruto de un proceso totalmente artesanal realizado por manos expertas que requiere tiempo y oficio para conseguir un acabado de calidad.

According to its context of use is available in various materials and finishes. The paper cord seat is the result of a totally handmade process carried out by expert hands that requires time and craft to achieve a high quality finish.





1. Bogart armchair code 501 / Frame: natural ash PO Extra Mate / Seat: double weave, natural paper cord
2. Bogart armchair code 501 / Frame: lacquered oak RAL 9004 PO Extra Mate / Seat and backrest: upholstered Gabriel Fame 60999
3. Bogart chair code 500 / Frame: lacquered ash RAL 9004 PO Extra Mate / Seat: quadruple weave, black paper cord



1. Bogart armchair code 501 / Frame: lacquered oak RAL 9004 PO Extra Mate / Seat and backrest: upholstered Gabriel Fame 60999
2. Bogart chair code 500 / Frame: lacquered ash RAL 9004 PO Extra Mate / Seat: quadruple weave, black paper cord





1

1. Bogart chair code 500 / Frame: lacquered ash RAL 5004 PO Extra Mate / Seat: wrapping with recycled leather H55F Nuit
2. Bogart armchair code 501 / Frame: Natural ash PO Extra Mate / Seat: double weave, natural paper cord

Bogart es una silla atemporal, robusta y confortable que se presenta en estructura de roble o fresno y en sus versiones con y sin brazos.

Bogart is a timeless, sturdy and comfortable chair that comes in oak or ash structure as its versions with or without arms.





1. Bogart chair code 500 / Frame: natural ash PO Extra Mate / Seat: double weave, natural paper cord
2. Bogart chair code 500 / Frame: lacquered oak RAL 7044 PO Extra Mate / Seat: wrapping with acrylic tape Mineral F206
3. Bogart chair code 500 / Frame: lacquered ash RAL 5004 PO Extra Mate / Seat: wrapping with recycled leather H55F Nuit

3





P. 56/57 Bogart armchair code 501 / Frame: natural oak PO Mate / Seat: wrapping with brown full grain leather





1

2

1. Cistell chair code 790-01 / Backrest and legs: lacquered ash RAL 5004 PO EM / Seat: upholstered Gabriel Select 66144.

2. Sandwich code 351-01 / Column: powder coated ARL 9004 textured / Top: Beech dyied white 93 MI.

Cistell Collection

Cistell Collection

– by Yago
Sarri

Cistell es una familia de sillas y silloncitos diseñada por Yago Sarri. Como nos sugiere su nombre, Cistell significa Cesta en catalán, se trata de un asiento envolvente y confortable. Con su silueta sinuosa y tranquila Cistell se adapta perfectamente a los espacios de reunión y restauración.

Cistell is a collection of chairs and armchairs designed by Yago Sarri. As its name suggest, Cistell means basket in catalan and it is an enveloping and comfortable seat. With its sinuous and calm silhouette Cistell fits perfectly into meeting and restaurant spaces.



P. 28 P. 29 Cistell armchair code 791-01 / Backrest and legs: dyied beech white 13 MI / Seat: upholstered Gabriel Select 60131.



1. Cistell chair code 790-01 / Backrest and legs: lacquered ash RAL 7044 PO EM / Seat: upholstered Gabriel Select 60132.
2. Sandwich table code 351-01 / Legs and base: Nickel matte 40 x 40 cm / Top: formica Infiniti Polar white, corner lacquered ash RAL 7044 PO EM 70 x 70 cm.
3. Cistell chair code 790-09 / Seat and backrest: upholstered Gabriel Select 66144 / Legs: natural beech Ml.
4. Cistell chair code 790-01 / Seat: upholstered Gabriel select 64144 / Backrest and legs: lacquered ash RAL 5004 PO EM.

1

2





3

4



Cistell chair code 790-03 / Backrest: lacquered ash RAL 9004 EM PO / Seat: upholstered Gabriel Select 60051 / Legs: steel tube finished powder coated RAL 9004 Textured.

Cistell Chair code 790-03 / Backrest: Natural ash PO EM / Seat: Upholstered Gabriel Select 60051 / Legs: Steel tube finished powder coated RAL 9004 textured.



1. Cistell armchair code 791-01 / Backrest and legs: dyied beech white 13 MI / Seat: upholstered Gabriel Select 60131.
2. Cistell armchair code 791-01 / Backrest and legs: lacquered ash Ral 5004 PO EM / Seat: upholstered Gabriel Select 66144.
3. Sandwich table code 351-01 / Column and base: powder coated RAL 5004 PO EM 73 h / Top: beech dyied white 93 MI 70 x 70 cm.
4. Cistell chair code 790-1 / Backrest and legs: lacquered ash Ral 5004 PO EM / Seat: upholstered Gabriel Select 66144.

1



2





3

4



Cistell armchair code 790-03 / Backrest: natural ash PO EM / Legs: steel tube finished powder coated RAL 7030 textured / Seat: upholstered Gabriel Select 64213.



1. Cistell armchair code 790-03 / Backrest: natural ash PO EM / Legs: steel tube finished powder coated RAL 7030 textured / Seat: upholstered Gabriel Select 64213.
2. Sandwich code 355-02 column: natural ash PO EM / Base: powder coated RAL 1013 matte Ø 60 cm / Top: natural ash PO EM Ø 90 cm.

1. Cistell armchair code 791-07 / Seat and backrest: upholstered Gabriel Select 60133 / Legs: Ash PO AN.
2. Cistell armchair code 791-01 / Backrest and legs: dyied beech white 13 MI / Seat: upholstered Gabriel Select 60131.
3. Cistell armchair code 791-01 / Backrest and legs: lacquered ash RAL 5004EM PO / Seat: upholstered Gabriel Select 66144.

1



2



La colección Cistell
facilita gran variedad
de combinaciones,
con distintos acabados
de la madera y tapizados,
invitando así a la
personalización según
diferentes entornos
o contextos de uso.

Cistell collection
facilitates a big variety
of combinations
with different finishes
of wood and upholstered,
inviting to customize it
according to its context.

3





Cistell armchair code 792-04 / Backrest and legs: natural walnut MI / Seat and interior backrest: upholstered Gabriel Select 61185.

1



2



1. Cistell armchair code 792-04 / Backrest and legs: natural walnut MI / Seat and interior backrest: upholstered Gabriel Select 61185.
2. Cistell Chair code 790-01 / Backrest and legs: Natural walnut MI / Seat: Upholstered Gabriel Select 61190.

Cistell es una colección de gran versatilidad, su respaldo se ofrece en tres modelos de contorno; todos ellos admiten la versión de madera natural, tintada o tapizada.

+ Info P.152

Cistell is a collection of great versatility, its backrest offers three models of outline and all of them admits the natural wood version or dry or entirely lacquered.

+ Info P.152



2



3





P.42 P.43 1. Cistell chair code 790-01 / Backrest and legs: lacquered ash RAL 7044 PO EM / Seat: upholstered Gabriel Select 60132.
2. Cistell armchair code 791-01 / Backrest and legs: dyed beech white 13 MI / Seat: upholstered Gabriel Select 60131.
3. Cistell chair code 792-07 / Backrest and legs: dyed beech Grey 74 MI/ Seat: upholstered Kvadrat Star 2 0787.
P.43 Cistell chair code 792-07 / Backrest and legs: dyed beech Grey 74 MI/ Seat: upholstered Kvadrat Star 2 0787.



1. Dula table code 338-01 / Legs: powder coated RAL 9003 Top DM RAL 9003 laquered matte.
2. Dula pouf code 346-01 / Upholstered: Gabriel harmony 3102 / Legs: powder coated RAL 9003 matte.
3. Dula code 340-01 / Upholstered: Gabriel Gabriel harmony 3102 / Legs: powder coated RAL 9003 matte.

Dula Collection

– by Yago
Sarri

La colección Dula es un sistema versátil de asientos modulares, diseñados por Yago Sarri, para equipar espacios de descanso y espera en halls, oficinas, hoteles... Se caracteriza por su confort, por sus dimensiones generosas y por unas formas sobrias que permiten crear múltiples configuraciones para adaptarse a las necesidades de cada proyecto.



Dula collection is a versatile system of modular seats, designed by Yago Sarri, to furnish rest and waiting areas in halls, offices, hotels, etc. Dula seats are comfortable thanks to their large size and simple shapes which can be used to create multiple setups to adapt to the needs of each project.





1. Dula pouf code 346-01 / Upholstered: Gabriel harmony 3102 / Legs: powder coated RAL 9003 matte.
2. Dula code 340-01 / Upholstered: Gabriel Gabriel harmony 3102 / Legs: powder coated RAL 9003 matte.
3. Dula table code 338-01 / Legs: powder coated RAL 9003 matte / Top: DM RAL 9003 matte.

Las alineaciones de asientos Dula pueden ubicarse exentas, las agrupaciones “back to back” permiten crear islas, para ordenar el espacio en zonas diáfanas.

Dula seats can be arranged separately, back-to-back groups can create islands, when organizing the space in open-plan areas.



3



Dula Collection

El programa Dula se complementa con mesas auxiliares que pueden utilizarse aisladamente o incorporarse al sistema lineal, entre los asientos o en los extremos del conjunto.

The Dula project is complemented with side tables that can be used in isolation or incorporated into the linear system, between the seats or at the ends of the unit.







1. Dula table code 338-01 / Legs: powder coated RAL 9003 matte / Top: DM RAL 9003 matte.



1

2



P.54 1. Dula code 340-01 / Upholstered: Gabriel harmony 3102 / Legs: powder coated RAL 9033 matte.
2. Dula cushion code 348-01 / Upholstered: Gabriel Hamony 1101.



1

2

1. Dula pouf code 341-01 / Upholstered: Gabriel Fame 64169 / Legs: powder coated RAL 9033 laquered matte.
2. Dula cushion code 348-02 / Upholstered: Gabriel Fame 63078.





P. 58 P. 59 1. Dula armchair code 341-01 / Upholstered: Gabriel Fame 68004 / Legs: powder coated RAL 1027 satin.
2. Dula cushion code 348-02 / Upholstered: Gabriel fame 60005.
3. Dula table code 338-03 / Legs: powder coated RAL 7030 textured / Top: dektion Olimpo Ø 110 cm.

La colección Dula también se presenta en versión de butaca individual o dos plazas. Ambos modelos se ofrecen en dos tipos de brazo: completamente tapizado para entornos de gran confort o en estructura tubular y madera en el reposabrazos, que le aportan contemporaneidad y transparencia.

+ Info P.156

The Dula collection also has a single or two-seater armchair version. Both models offer two types of arm: fully upholstered for highly comfortable environments or with a transparent tubular wooden structure in the armrest, which gives it a touch of modernity.

+ Info P.156



1

2

3

1. Dula armchair code 342-02 / Upholstered: Gabriel Harmony 2102 / Legs: powder coated 7030 textured / Armrests: natural oak wood EM.
2. Dula cushion code 348-02 / Upholstered: Gabriel harmony 1101.
3. Dula table code 338-03 / Top: natural Oak EM / Legs: powder coated 7030 textured.
4. Dula armchair code 340-02 / Upholstered: Gabriel Harmony 2102 / Legs: powder coated 7030 textured / Armrests: natural oak wood EM.
5. Dula cushion 348-02 / Upholstered: Gabriel harmony 3101.





4

5





P.62 P.63 1. Dula armchair code 340-02 / Seat and backrest: upholstered Gabriel harmony 2102 / Armrest: Natural Oak EM / Legs: powder coated RAL 7030 textured.
2. Dula cushion code 348-02 / Upholstered: Gabriel harmony 3101.



1

2

3



P.64 P.65 1. Dula armchair code 340-02 / 2. Dula sofa code 342-02 / 1. 2. Seat and backrest: upholstered Gabriel harmony 2102 / Armrest: Natural Oak EM / Legs: powder coated RAL 7030 textured.
3. Dula table code 338-03 / Legs: powder coated RAL 7030 textured / Top: natural ash EM.



2

1

1. Glöwr table wooden base code 783 – Base: beech solid wood dyied Grey 74 EM. / Glöwr wooden top code 009, 80 x 80 cm – Top: Plywood laminated Infinity Surf F7923. Edge dyied Grey 74 EM.
2. Glöwr chair code 780 / Frame: solid beech wood dyied Orange 83 EM / Seat and backrest: beech veneer dyied Orange 83 EM.

Glöwr Collection

Glöwr Collection

– by Claire
Davies

Diseñada por Claire Davies, Glöwr es el tipo de silla cálida y acogedora. Es una pieza sobria, robusta y duradera. Sus líneas sencillas y tranquilas, junto al uso de la madera, aportan cierta domesticidad y calidez a los espacios de restauración y hostelería.



Designed by Claire Davies, the Glöwr is a warm and welcoming chair. It's a sober, robust and long-lasting piece. Its simple and smooth lines, together with the use of wood, provide domesticity and warmth to restaurant and hotel spaces.

P.80 Glöwr chair code 780 / Frame: solid beech wood dyied White 13
/ Backrest: beech veneer dyied White 13 EM / Seat: upholstered Gabriel Fame 68148.
P.81 Glöwr chair code 780 / Frame: solid beech wood dyied Grey 74 EM
/ Backrest: beech veneer dyied Grey 74 EM / Seat: upholstered Gabriel Fame 61136.





P.82 Glöwr chair code 780 / Frame: solid beech wood dyied White 13 EM / Backrest: beech veneer dyied White 13 EM / Seat: upholstered Gabriel Fame 61131.
P.83 1. Glöwr table wooden base code 783 – Base: beech solid wood dyied Grey 74 EM. / Glöwr wooden top code 009, 80 x 80 cm – Top: Plywood laminated Infinity Surf F7923. Edge dyied Grey 74 EM.
2. Glöwr chair code 780 / Frame: solid beech wood dyied White 13 EM / Backrest: beech veneer dyied White 13 EM / Seat: upholstered Gabriel Fame 61131.



1

2

101



1

2



P.84 P.85 1. Glöwr stool code 782 / Frame: solid beech wood dyied Green 66 EM
/ Seat and backrest: beech veneer dyied Green 66 EM.

2. Glöwr stool code 782 / Frame: solid beech wood dyied Grey 74 EM / Backrest: beech
veneer dyied Grey 74 EM / Seat and front backrest: upholstered Gabriel Fame 68148.

3. Glöwr lounge code 781 / Frame: solid beech wood dyied Grey 74 EM / Backrest: beech
veneer dyied Grey 74 EM / Seat: upholstered Gabriel Fame 68148.

La colección Glöwr se compone de una silla apilable, taburete alto, sillón lounge y mesas, todas ellas con estructura de madera de haya y piezas de unión en latón que aportan un acento refinado al conjunto.

The Glöwr collection includes a stackable chair, high stool, lounge armchair and tables, all with a beechwood frame and brass joints that provide a refined touch.



1

2

3



1. Glöwr chair code 780 / Frame: solid beech wood dyied Grey 74 EM
/ Backrest: beech veneer dyied Grey 74 EM / Seat: upholstered Gabriel Fame 61136.
2. Glöwr table wooden base code 783 – Base: beech solid wood dyied Grey 74 EM.
/ Glöwr wooden top code 009 80 x 80 cm – Top: beech plywood dyied Green 63 EM.
3. Glöwr chair code 780 / Frame: solid beech wood dyied White 13 EM
/ Backrest: beech veneer dyied White 13 EM / Seat: upholstered Gabriel Fame 68148.
4. Glöwr chair code 780 / Frame: solid beech wood dyied Grey 74 EM
/ Seat and backrest: beech veneer dyied Green 63 EM.
5. Glöwr table wooden base code 783 – Base: beech solid wood dyied Grey 74 EM.
/ Glöwr wooden top code 009, 80 x 80 cm – Top: plywood laminated Infinity Surf F7923. Edge dyied Grey 74 EM.
6. Glöwr chair code 780 / Frame: solid beech wood dyied Grey 74 EM
/ Backrest: beech veneer dyied Grey 74 EM / Seat and front backrest: upholstered Gabriel Fame 61136.





Glöwr Collection



P.88 P.89 Glöwr lounge code 781 / Frame: solid beech wood dyied Blue 54 EM
/ Backrest: beech veneer dyied Blue 54 EM / Seat: upholstered Gabriel Fame 60017.

Mediante combinaciones con la tapicería, piel y los tonos de madera, los tres asientos permiten múltiples variaciones y cambios de aspecto.

+ Info P.166

Through combinations of tapestry, leather and wood tones, it's possible to modify the chairs in a variety of ways and change their appearance.

+ Info P.166





P.90 P.91 Glöwr lounge code 781 / Frame: solid beech wood dyied White 13 EM
/ Backrest: beech veneer dyied White 13 EM / Seat: upholstered leather Penelopeoggi Nuvola P0151.

1. Kimmi chair code 255 / Frame: powder coated RAL 9003 matte / Seat: beech veneer lacquered RAL 9003 EM / Backrest: beech veneer dyied White 93 EM.
2. Kimmi table metal base code 257 – Base: powder coated RAL 9003 matte.
/ Kimmi top code 260, Ø60 cm – Top: Beech veneer dyied White 93 EM. Metal edge powder coated RAL 9003 matte.



Kimmi Collection

– by Roger
Vancells

Diseñada por Roger Vancells, Kimmi es una silla expresiva, de líneas sobrias y contemporáneas. Conecta de manera honesta e ingeniosa dos piezas de madera contrachapada para construir el asiento y el respaldo. Jugando con los acabados y combinando maderas naturales o lacadas, así como los tapizados, se consiguen sillas con equilibradas composiciones cromáticas.

Designed by Roger Vancells, the Kimmi is an expressive chair with sober and contemporary lines. It ingeniously and naturally joins two pieces of laminated wood to form the seat and back. Chairs with balanced chromatic compositions are created by playing with finishes and combining natural and lacquered woods, as well as upholsteries.



P.94 P.95 Kimmi chair code 255 / Frame: powder coated RAL 5004 satin / Seat: upholstered Gabriel Atlantic 60011 / Backrest: ash veneer lacquered RAL 5004 PO AN.



1. Kimmi chair code 256 / Frame: powder coated RAL 7030 matte
/ Seat and backrest: ash veneer lacquered RAL 7030 PO AN
/ Legs: ash solid wood lacquered RAL 7030 PO AN.
2. Kimmi chair code 256 / Frame: powder coated RAL 1013 matte
/ Seat and backrest: ash veneer varnished natural EM
/ Legs: ash solid wood varnished natural EM.

1

2



Kimmi Collection



1. Kimmi chair code 253 / Frame: powder coated RAL 6006 matte / Seat: upholstered Spradling Dolce Moss 6717 / Backrest: ash veneer varnished natural EM.
2. Kimmi chair code 256 / Frame: powder coated RAL 1013 matte / Seat and backrest: ash veneer varnished natural EM / Legs: ash solid wood varnished natural EM.

Kimmi es una colección que por su diseño se adapta a los ambientes de trabajo informales y a los espacios de restauración modernos. Se presenta en cuatro tipologías de estructura, con patas de tubo metálico o de madera, patas de patín o bien giratoria de cuatro radios.

Because of its design, the Kimmi collection can be adapted to both casual work environments and modern restaurant spaces. It comes in four frame types: metal or wood tube legs, a sled base or a swivel base with four spokes.



1. Kimmi chair code 253 / Frame: powder coated RAL 6006 matte / Seat: upholstered Spradling Dolce Moss 6717 / Backrest: ash veneer varnished natural EM.
2. Kimmi chair code 254 / Frame: powder coated RAL 6006 matte / Seat and backrest: ash veneer lacquered RAL 6006 PO AN.
3. Kimmi table metal base code 258 – Base: Powder coated RAL 6006 matte. / Kimmi top code 260, Ø 70 cm – Top: ash veneer varnished natural EM. Metal edge powder coated RAL 6006 matte.
4. Kimmi table metal base code 258 – Base: powder coated RAL 6006 matte. / Kimmi top code 260, Ø 70 cm – Top: Dekton Edora textured. Metal edge powder coated RAL 6006 matte.
5. Kimmi chair code 256 / Frame: powder coated RAL 7030 matte / Seat and backrest: ash veneer lacquered RAL 7030 PO AN / Legs: ash solid wood lacquered RAL 7030 PO AN.
6. Kimmi chair code 256 / Frame: powder coated RAL 1013 matte / Seat and backrest: ash veneer varnished natural EM / Legs: ash solid wood varnished natural EM.



5

6

Las sillas se complementan con mesas de tres alturas distintas. Construidas con estructura tubular metálica lacada, sus sobres están embutidos en un marco metálico perimetral.

+ Info P.170

The chairs are complemented by tables of three different heights. Built with a lacquered metal tubular structure, the tabletop is framed by a metal border.

+ Info P.170





P:100 P:101 1. Kimmi table metal base code 259 – Base: powder coated RAL 8000 textured.
/ Kimmi top code 260, Ø 50 cm – Top: Dekton Zenith matte. Metal edge powder coated RAL 8000 textured.
2. Kimmi table metal base code 258 – Base: powder coated RAL 6006 matte.
/ Kimmi top code 260, Ø 70 cm – Top: Dekton Edora textured. Metal edge powder coated RAL 6006 matte.

1. Kimmi chair code 255 / Frame: powder coated RAL 5004 satin / Seat: upholstered Gabriel Cura 60111 / Backrest: ash veneer lacquered RAL 5004 PO AN.
2. Kimmi chair code 255 / Frame: powder coated RAL 3012 satin / Seat: upholstered Spradling Valencia Nectarine 107-6003 / Backrest: ash veneer lacquered RAL 3012 PO AN.





2



Mim chair code 754 / Frame: powder coated RAL 7044 matte / Seat: upholstered Go Uni 60093
/ Backrest: beech solid wood dyied white 93 EM.

Mim Collection

Mim Collection

– by Tarruella Trenchs
Studio

Mim es una amplia colección de gran ligereza visual diseñada por Tarruella Trenchs Studio. Tanto su versatilidad en acabados, como su lenguaje atemporal y honesto, la hacen muy adecuada para equipar interiores rústicos y sofisticados, de restaurantes, cafeterías y zonas de espera.



P:106 P:107 Mim chair code 754 / Frame: powder coated RAL 8023 matte / Seat: upholstered Gabriel Gocheck 63080 / Backrest: oak solid wood varnished natural EM.

Mim is an extensive, visually lightweight collection designed by Tarruella Trenchs Studio. Both its versatility in finishes and its timeless and honest language make it perfectly suited for the rustic and sophisticated interiors of restaurants, cafeterias and waiting areas.



En Mim, las sillas, bancos, taburetes y mesas combinan con sutileza las livianas estructuras metálicas con la calidez de los asientos textiles, los respaldos de madera maciza y la robustez de la piedra en el sobre de las mesas.

+ Info P.174

In Mim, the chairs, benches, stools and tables subtly combine lightweight metal frames with warm fabric seats, solid wood backs and robust stone tabletops.

+ Info P.174



1. Mim table metal base code 762 – Base: powder coated RAL 6006 matte. / Mim top code 758, Ø40 cm
– Top: Dekton Galema / Walnut solid wood edge, varnished natural EM.
2. Mim bench code 757 / Frame: powder coated RAL 6006 matte / Seat: upholstered Gabriel Gocheck 61139 / Backrest: walnut solid wood varnished natural EM.
3. Mim cushion code 759 / Upholstered Gabriel Gocheck 61139.



3



1

2



P.110 1. Mim chair code 754 / Frame: powder coated RAL 7044 matte / Seat: upholstered Gabriel Gocheck 60093 / Backrest: oak solid wood varnished natural EM.
2. Mim table metal base code 764 – Base: Powder coated RAL 7044 matte. / Mim top code 758, Ø70 cm – Top: Infinity Surf F7923. Oak solid wood edge, varnished natural EM.
P.111 Mim chair code 754 / Frame: powder coated RAL 7039 matte / Seat: upholstered Gabriel Gocheck 60093 / Backrest: oak solid wood varnished natural EM.



1. Mim chair code 754 / Frame: powder coated RAL 8023 matte / Seat: upholstered Gabriel Gocheck 63080 / Backrest: beech solid wood lacquered RAL 8023 AN.
2. Mim bench code 757 / Frame: powder coated RAL 5004 matte / Seat: upholstered Gabriel Gocheck 60080 / Backrest: beech solid wood dyied White 93 EM.
3. Mim stool code 755 / Frame: powder coated RAL 5004 matte / Seat: upholstered Gabriel Gocheck 66140 / Backrest: beech solid wood dyied White 93 EM.





1



2





P:114 P:115 1. Mim chair code 754 / Frame: powder coated RAL 9004 matte
/ Seat: upholstered Gabriel Gocheck 60084 / Backrest: oak solid wood varnished natural EM.
2. Mim table metal base code 764 – Base: Powder coated RAL 9004 matte.
/ Mim top code 758, Ø70 cm – Top: Dekton Sirius. Oak solid wood edge, varnished natural EM.

Naoshima stool code 702 / Legs: beech solid wood dyied White 13 EM
/ Seat: beech veneer dyied White 13 EM.



Naoshima Collection

Naoshima Collection

– by Emiliana
Design Studio

La colección de taburetes Naoshima diseñada por Emiliana Design Studio experimenta con el potencial expresivo y estructural de la madera curvada. La sinuosa silueta del asiento, virtuosamente ensamblado, nos sugiere un juego visual entre la materia y el vacío.



P.118 P.119 Naoshima stool code 702 / Legs: oak solid wood varnished natural EM / Seat: oak veneer laquered RAL 9004 PO EM.

The Naoshima stool collection designed by Emiliana Design Studio plays with the expressive and structural potential of curved wood. The virtuously assembled meandering silhouette of the seat suggests visual play between matter and nothingness.



Naoshima stool code 702 / Legs: beech solid wood dyied White 13 EM
/ Seat: beech veneer dyied White 13 EM.



Naoshima Collection





P.122 Naoshima stool code 703 / Legs: oak solid wood lacquered RAL 6006 PO AN
/ Seat: oak veneer lacquered RAL 6006 PO AN.
P.123 Naoshima stool code 703 / Legs: oak solid wood varnished natural EM
/ Seat: oak veneer varnished natural EM.



1. Naoshima stool code 703 / Legs: oak solid wood lacquered RAL 1027 PO AN
/ Seat: oak veneer lacquered RAL 1027 PO AN.
2. Naoshima stool code 702 / Legs: beech solid wood dyied White 13 EM
/ Seat: beech veneer dyied White 13 EM.
3. Naoshima stool code 701 / Legs: oak solid wood lacquered RAL 9004 PO EM
/ Seat: oak veneer lacquered RAL 9004 PO EM.
4. Naoshima stool code 702 / Legs: oak solid wood varnished natural EM
/ Seat: oak veneer laquered RAL 9004 PO EM.
5. Naoshima stool code 703 / Legs: oak solid wood varnished natural EM
/ Seat: oak veneer varnished natural EM.





4



5



Disponibile en tres alturas diferentes, el taburete combina cuatro piezas idénticas para construir el asiento, la prolongación del cual conecta con patas de madera maciza creando un conjunto sólido y estable.

+ Info P.178

Available in three different heights, the stool joins four identical pieces to create the seat, the extension of which connects to solid wood legs, creating a strong and stable result.

+ Info P.178





P.126 Naoshima stool code 702 / Legs: beech solid wood dyied White 13 EM
/ Seat: beech veneer dyied White 13 EM.
P.127 Naoshima stool code 703 / Legs: oak solid wood lacquered RAL 1027 PO AN
/ Seat: oak veneer lacquered RAL 1027 PO AN.

1. Naoshima stool code 703 / Legs: oak solid wood varnished natural EM
/ Seat: oak veneer varnished natural EM.

2. Naoshima stool code 703 / Legs: oak solid wood lacquered RAL 1027 PO AN
/ Seat: oak veneer lacquered RAL 1027 PO AN.

3. Naoshima stool code 703 / Legs: oak solid wood lacquered RAL 6006 PO AN
/ Seat: oak veneer lacquered RAL 6006 PO AN.





3

1



2



1. Sandwich table code 354-01 / Base and column: powder coated Ral 9003 matte / Top: color core Compact Polar White AN Infinity Ø 60 cm.

2. Sandwich table code 351-01 / Base and column: powder coated Ral 7044 matte / Top: Formica Infinity Polar with the corner lacquered ash RAL 7044 PO EM 70 x 70 cm.

Sandwich Collection

– by Untaller

Sandwich, diseñada por el estudio Untaller, es una colección de mesas de gran polivalencia destinada al mundo de la restauración y cafeterías. Sandwich es una mesa robusta y sobria, en la que su “doble” columna le confiere un carácter distintivo.

Sandwich, designed by Untaller studio, is a collection of tables of great versatility destined to the world of restaurant spaces and coffee shops. Sandwich is a robust and sober table where its “double” column gives a distinctive character.



P. 132 P. 133 Sandwich table code 351-02 / Column: natural ash AN / Base: powder coated RAL 9004 satin / Top: natural ash AN 70 x 70 cm.





P. 135 P. 135 1. Sandwich table code 354-01 / Base and column: powder coated RAL 9003 matte
/ Top: dekton Kairos Ø 60 cm.
2. Sandwich table code 351-01 / Base and column: powder coated RAL 9004 textured
/ Top: silestone Charcoal soapstone 70 x 70 cm.
3. Sandwich table code 357-01 / Base and column: powder coated RAL 9003 textured
/ Top: Dekton Sogne 110 x 70 cm.

Sandwich permite
diversas posibilidades
de configuración tanto
en su formato como por
el abanico de materiales
disponibles.

Sandwich allows
different possibilities
of configuration both
in its format and
by the big variety
of distinct materials.



1. Cistell chair code 790-03 / Upholstered: Gabriel Select 60051 / Backrest: powder coated ash 9004 EM / Legs: steel tube finished powder coated RAL 9004 textured.
2. Sandwich table code 351-02 / Column: natural ash AN / Base: powder coated RAL 9004 satin / Top: natural ash AN 70 x 70 cm.
3. Sandwich table code 351-01 / Base and column: powder coated RAL 9004 EM matte / Top: formica Infiniti Diamond black / Corner: natural ash matte 70 x 70 cm.
4. Sandwich table code 351-01 / Base and column: powder coated RAL 9004 matte / Top: natural ash AN 70 x 70 cm.

1



2



3

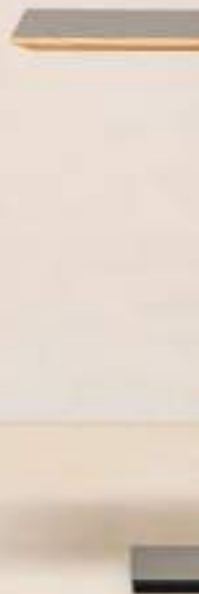



4

La columna, que caracteriza la mesa Sandwich, ofrece la opción de ser personalizada aplicando distintos acabados de madera en combinación con el pie o el sobre.

The column, which characterizes the Sandwich table, offers the option of being customized applying distinct finishes of wood in combination with the base or the top.

1

2

1. Sandwich table code 351-02 / Column: natural ash AN / Base: lacquered RAL 9004 satin / Top: natural ash AN 70 x 70 cm.

2. Cistell chair code 790-03 / Upholstered: Gabriel Select 60051 / Backrest: lacquered ash 9004 PO EM / Legs: steel tube finished powder coated RAL 9004 textured.



Sandwich table code 351-01 / Base and column: powder coated RAL 9004 matte / Top: formica Infiniti Diamond black / Corner: natural ash matte 70 x 70 cm.



Sandwich table code 356-01 / Base and column: powder coated RAL 9003 matte
/ Top: natural ash EM Ø 90 cm.

1. Cistell chair code 790-03 / Upholstered gabriel select 64213 / Backrest: natural ash EM / Legs: steel tube finished powder coated RAL 7030 textured.
2. Sandwich table code 356-02 / Column: Natural ash EM 60 72 h / Base: powder coated RAL 9003 matte / Top: Natural ash EM Ø 90 cm.



1

2



1

2

1. Cistell chair code 790-03 / Backrest: lacquered ash RAL 9004 PO EM / Seat: upholsted Gabriel Select 60051 / Legs: steel tube finished powder coated RAL 9004 textured.

2. Sandwich table code 359-01/ Column: natural ash EM 60 72h / Base: powder coated RAL 9004 matte / Top: natural ash EM Ø 140 cm.

3. Cistell chair code 792-09 / Seat and backrest: upholstered Gabriel Select 60051 / Legs: steel tube finished powder coated RAL 9004 textured.

4. Cistell chair code 790-03 / Backrest: natural ash EM / Seat: upholstered Gabriel Select 60051 / Legs: steel tube finished powder coated RAL 9004 textured.

En su versión de gran formato la elegante columna de la mesa Sandwich admite diversos materiales y propone además un sugerente juego visual según su punto de vista.

+ Info P.180

In its version of big format the elegant column of the Sandwich table admits different materials and it also proposes a suggesting visual game according to your point of view.

+ Info P.180





P.144 P.145 1. Sandwich table code 359-01 / Column: Dekton Fossil / Base: powder coated RAL 9004 textured / Top: Dekton Fossil Ø 140 cm.
2. Cistell chair code 792-09 / Seat and backrest: upholstered Gabriel Select 60051 / Legs: steel tube finished powder coated RAL 9004 textured.



1

2



Product information

“Cuando Esteve y Joan Vergés nos pidieron asumir la dirección de arte de esta nueva etapa, tuvimos claro que el territorio donde se encuentra Vergés sería una sugerente fuente de inspiración. En la Garrotxa, una zona de origen volcánico en el que abundan bosques y hayedos, los cambios de estación son muy perceptibles en el entorno natural, toda esta riqueza de tonalidades y matices han sido sin duda un gran referente a la hora de seleccionar los colores y acabados para la colección de Vergés 2020.”

Ana Mir, emiliana design studio

‘When Esteve and Joan asked to take over art direction for this new phase, we knew the land surrounding the Vergés’ facilities would be an enticing source of inspiration. In Garrotxa, an area with volcanic origins where forests and beech trees flourish, seasonal changes in the natural landscape are highly noticeable. No doubt, those rich tonalities and nuances have served as a reference for selecting the colours and finishes of the 2020 Vergés collection.’

Ana Mir, emiliana design studio

ABC Collection

by Lázaro Rosa-Violán

Modelos / Models

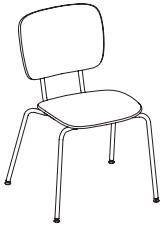

970

Respaldo y asiento / Backrest & seat

Contrachapado de haya o fresno acabados madera natural, haya tintada y fresno lacado. / Beech or Ash Plywood Finishes in natural wood, dye beech and lacquered ash.

Estructura / Frame Patatas acero / Metal legs

Tubo de acero pintado en polvo con colores RAL. / Steel tube finished powder - coated with RAL colors.

Tapizado / Upholstery

Tapizado de asiento, o en el conjunto de asiento y respaldo. / Upholstered seat or upholstered seat and backrest.

Peso / Weight

5,1 kg/u

Volumen caja / Volumetric Packaging

2 u. 58 x 68 x 89 cm

Apilable* / Stackable*

Hasta 5 u / Up to 5 u
*Excepto con tapizado.
/ *Except with upholstery.



971

Respaldo y asiento / Backrest & seat

Contrachapado de haya o fresno acabados madera natural, haya tintada y fresno lacado. / Beech or Ash Plywood Finishes in natural wood, dye beech and lacquered ash.

Estructura / Frame Patatas acero / Metal legs

Tubo de acero pintado en polvo con colores RAL. / Steel tube finished powder - coated with RAL colors.

Tapizado / Upholstery

Tapizado de asiento, o en el conjunto de asiento y respaldo. / Upholstered seat or upholstered seat and backrest.

Peso / Weight

7 kg/u

Volumen caja / Volumetric Packaging

2 u. 58 x 68 x 89 cm

Apilable* / Stackable*

Hasta 5 u / Up to 5 u
*Excepto con tapizado.
/ *Except with upholstery.



972

Respaldo y asiento / Backrest & seat

Contrachapado de haya o fresno acabados madera natural, haya tintada y fresno lacado. / Beech or Ash Plywood Finishes in natural wood, dye beech and lacquered ash.

Estructura / Frame

Tubo de acero pintado en polvo con colores RAL. / Steel tube finished powder - coated with RAL colors.

Patatas madera / Wooden Legs

Patatas de madera maciza de haya o fresno. / Beech or ash solid wood legs.

Tapizado / Upholstery

Tapizado de asiento, o en el conjunto de asiento y respaldo. / Upholstered seat or upholstered seat and backrest.

Peso / Weight

7 kg/u

Volumen caja / Volumetric Packaging

2 u. 49x 59 x 97 cm



973

Respaldo y asiento / Backrest & seat

Contrachapado de haya o fresno acabados madera natural, haya tintada y fresno lacado. / Beech or Ash Plywood Finishes in natural wood, dye beech and lacquered ash.

Estructura / Frame

Tubo de acero pintado en polvo con colores RAL. / Steel tube finished powder - coated with RAL colors.

Patatas madera / Wooden Legs

Patatas de madera maciza de haya o fresno. / Beech or ash solid wood legs.

Tapizado / Upholstery

Tapizado de asiento, o en el conjunto de asiento y respaldo. / Upholstered seat or upholstered seat and backrest.

Peso / Weight

9,8 kg/u

Volumen caja / Volumetric Packaging

1 u. 55x 55 x 90 cm

Medidas / Dimensions

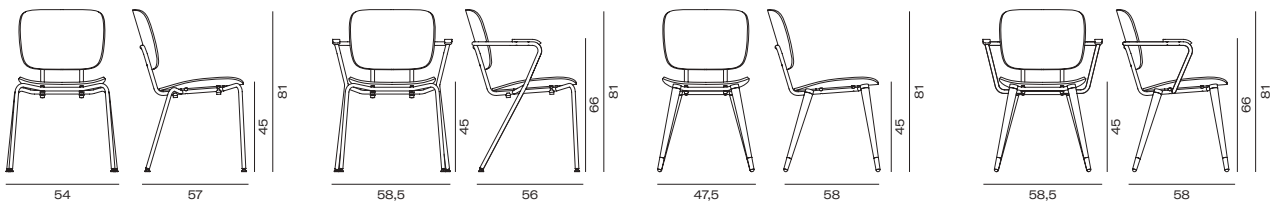

Respaldo y asiento / Backrest & seat
Madera contrachapada / Veneer plywood.

Patas madera / Wooden Legs
Madera maciza / Solid Wood.



Estructura / Frame

Patas acero / Metal legs

Tubo de acero pintado en polvo con colores RAL. / Steel tube finished powder - coated with RAL colors.

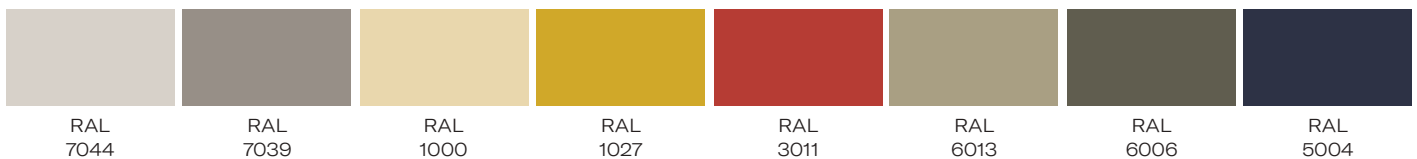

Acabados metálicos / Metal finishes

Acabados RAL / RAL finishes



Tapizado / Upholstery

Textiles (lana) / Fabrics (wool), Gabriel – Note & Harmony.



Todos los acabados que se muestran a continuación forman parte de una elaborada selección. Para ver carta completa de acabados dirigirse a pág. 184. / All finishes shown below are part of an elaborate color palette. To see the complete catalogue of finishes see page 184.

Certificados / Certificates

Modelos / Models 971 – 972. EN 1728:2012 + AC:2013.

ABC Collection

by Lázaro Rosa-Violán

Modelos / Models



974

Base metàlica / Metal base

3 patas con niveladores ajustables. Tubo de acero pintado con pintura en polvo poliéster en colores RAL. Sobre máximo aconsejado de Ø 70 cm. Con articulación abatible. / 3 steel legs with adjustable leveling feet. polyester powder coating in RAL colors.

Top recommended maximum of Ø 70 cm. With folding top pivot.

Peso / Weight

7 kg/u

Volumen caja / Volumetric Packaging

1 u. 62 x 54 x 75 cm



975

Base metàlica / Metal base

4 patas con niveladores ajustables. Tubo de acero pintado con pintura en polvo poliéster en colores RAL. Sobre máximo aconsejado de 80 x 80 cm. Con articulación abatible. / 4 steel legs with adjustable leveling feet. polyester powder coating in RAL colors.

Top recommended maximum of 80 x 80 cm. With folding top pivot.

Peso / Weight

7,5 kg/u

Volumen caja / Volumetric Packaging

1 u. 52 x 52 x 75 cm



977

Sobre / Top

MDF chapado de madera de haya, fresno o laminado de Formica Infiniti. Acabados disponibles en madera natural, tinte o laca. / MDF veneered with beech veneer, ash veneer or Formica laminated. Finishes are available in natural wood, dye or lacquer.

Peso / Weight

Segun medidas y acabados. / Depending on size & finish.

Volumen caja / Volumetric Packaging

2 u. Ø 60 o/or 60 x 60
= 62 x 62 x 2,5 cm
2 u. Ø 70 o/or 70 x 70
= 72 x 72 x 2,5 cm
2 u. Ø 80
= 82 x 82 x 2,5 cm

Medidas / Dimensions

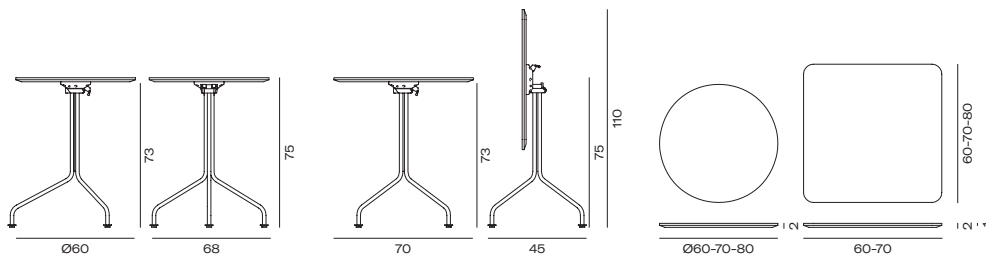

Sobre madera / Wooden top

Madera contrachapada de haya y fresno. / Beech and ash plywood.

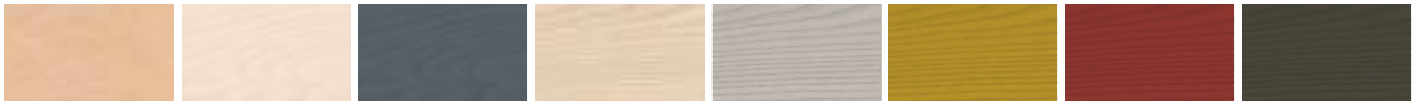

Haya natural
/ Natural beech

Haya / Beech
White 93

Haya / Beech
Grey 79

Fresno natural
/ Natural ash

Fresno / Ash
7044 PO

Fresno / Ash
1027 PO

Fresno / Ash
3011 PO

Fresno / Ash
6006 PO



Fresno / Ash
5004 PO

Sobre Formica / Formica top

Laminado HPL. / HPL laminate.



Infiniti
F7858

Infiniti
F7923

Infiniti
F7927

Infiniti
F7961

Infiniti
F4161

Infiniti
F7966

Infiniti
F2297

Infiniti
F2253

Base metálica / Metal base

Tubo de acero pintado en polvo con colores RAL. / Steel tube finished powder - coated with RAL colors.



RAL
7044

RAL
7039

RAL
1000

RAL
1027

RAL
3011

RAL
6013

RAL
6006

RAL
5004

Acabados metálicos / Metal finishes

Acabados RAL / RAL finishes



Powder Coated
Bright chromed

Powder Coated
Matt chromed

Powder Coated
Matt black
platine

Powder Coated
Matt brass

Powder Coated
Matt cooper

RAL
Satin

RAL
Matt

RAL
Textured

Bernardes Collection by Andreu Carulla

Modelos / Models

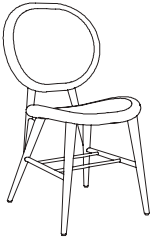

290

Estructura / Frame

Asiento, respaldo y patas de madera maciza de haya. Interior del respaldo con rejilla de rattan.
/ Seat, backrest and legs in solid beech wood. Inside of backrest with rattan mesh.

Tapizado / Upholstery

Tapizado disponible para el asiento. / Upholstery available in seat.

Peso / Weight

8,5 kg/u

Volumen caja / Volumetric Packaging

2 u. 49 x 65 x 113 cm

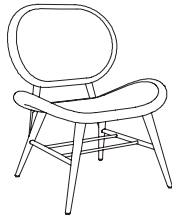

293

Estructura / Frame

Asiento, respaldo y patas de madera maciza de haya. Interior del respaldo con rejilla de rattan.
/ Seat, backrest and legs in solid beech wood. Inside of backrest with rattan mesh.

Tapizado / Upholstery

Tapizado disponible para el asiento. / Upholstery available in seat.

Peso / Weight

9 kg/u

Volumen caja / Volumetric Packaging

1 u. 58 x 68 x 89 cm

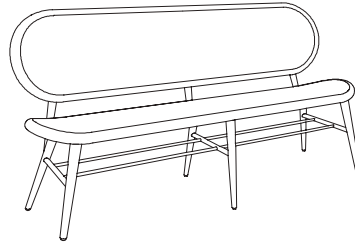

292

Estructura / Frame

Asiento, respaldo y patas de madera maciza de haya. Interior del respaldo con rejilla de rattan.
/ Seat, backrest and legs in solid beech wood. Inside of backrest with rattan mesh.

Tapizado / Upholstery

Tapizado disponible para el asiento. / Upholstery available in seat.

Peso / Weight

15 kg/u

Volumen caja / Volumetric Packaging

1 u. 158 x 58 x 90 cm

Premios / Awards



Silver Delta
ADI Awards
2016

Medidas / Dimensions

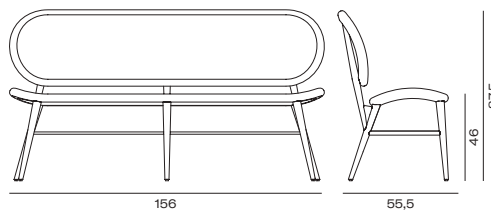
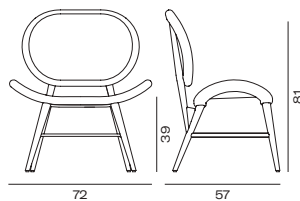
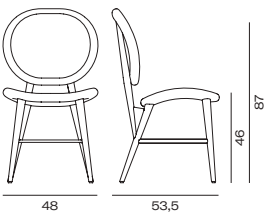

Estructura / Frame

Madera maciza de haya. / Solid beech wood.



Malla rattan / Cane mesh

Malla natural o tintada (celulosa). / Natural mesh or dye (cellulose).

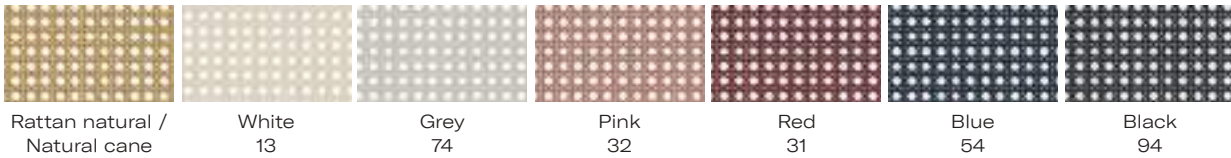

Tapizado / Upholstery

Textiles (lana) / Fabrics (wool), Gabriel – Mood. Piel Vegana (PV) / Vegan leather, Spradling – Dolce.

Piel Natural / Natural leather, Penelopeoggi – Nuvola Pesca.



Todos los acabados que se muestran a continuación forman parte de una elaborada selección. Para ver carta completa de acabados dirigirse a pág. 184. / All finishes shown below are part of an elaborate color palette. To see the complete catalogue of finishes see page 184.

Certificados / Certificates

Modelo / Model 290. EN 1728:2012 + AC:2013.

Bogart Collection by Manel Molina Studio

Modelos / Models

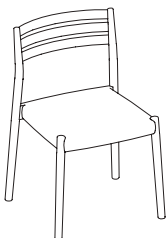

500

Estructura

Estructura apilable en madera de fresno o roble macizo, acabados en color natural, tintados o lacados a poro abierto.

Acabados disponibles

1. Asiento en cuerda de papel de Ø3mm color natural o negro, tejido en pasadas de 2 o 4.
2. Asiento en cintas de poliéster acrílico teñido, de 2mm de espesor.
3. Asiento en cintas de cuero reciclado de 2mm.
4. Asiento en cintas de cuero natural plena flor, de 3mm de espesor.
5. Asiento espumado y tapizado sobre cinchas elásticas. En esta opción también se ofrece la posibilidad de tapizar el respaldo.

Peso

6 kg/u

Volumen caja

2 u. 58x 68 x 89 cm

Frame

Stackable structure in ash wood or solid oak, finishes in natural colour, stained or laquered open pore.

Available finishes

1. Seat in natural or black paper rope of Ø3mm, woven in passes of 2 or 4.
2. Seat in dyed acrylic polyester ribbons, 2mm thick.
3. Seat in recycled leather ribbons, 3mm thick.
4. Seat in full grain leather ribbons, 3mm thick.
5. Seat foamed and upholstered in elastic straps. This option also offers the possibility of upholster the backrest.

Weight

6 kg/u

Volumetric Packaging

2 u. 58x 68 x 89 cm

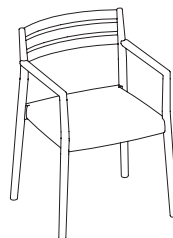

501

Estructura

Estructura en madera de fresno o roble macizo, acabados en color natural, tintados o lacados a poro abierto.

Acabados disponibles

1. Asiento en cuerda de papel de Ø3mm color natural o negro, tejido en pasadas de 2 o 4.
2. Asiento en cintas de poliéster acrílico teñido, de 2mm de espesor.
3. Asiento en cintas de cuero reciclado de 2mm.
4. Asiento en cintas de cuero natural plena flor, de 3mm de espesor.
5. Asiento espumado y tapizado sobre cinchas elásticas. En esta opción también se ofrece la posibilidad de tapizar el respaldo.

Peso

7 kg/u

Volumen caja

1 u. 58 x68x 89cm

Frame

Structure in ash or solid oak wood, natural color finishes, stained or lacquered open pore.

Available finishes

1. Seat in natural or black paper rope of Ø3mm, woven in passes of 2 or 4.
2. Seat in dyed acrylic polyester ribbons, 2mm thick.
3. Seat in recycled leather ribbons, 3mm thick.
4. Seat in full grain leather ribbons, 3mm thick.
5. Seat foamed and upholstered in elastic straps. This option also offers the possibility of upholster the backrest.

Weight

7 kg/u

Volumetric Packaging

1 u. 58 x68x 89cm

Certificados / Certificates

Modelo / Model 500. 1st Level EN 16139:2013.

Medidas / Dimensions

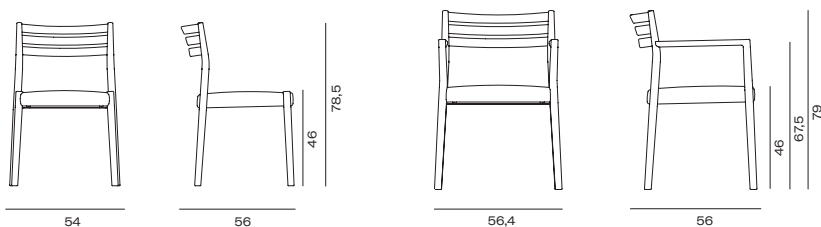

Estructura / Frame

Madera / Wood



Roble Natural /
Natural Oak

Fresno Natural /
Natural Ash

Fresno / Ash
5004 PO

Fresno / Ash
8023 PO

Fresno / Ash
9004 PO

Fresno / Ash
7044 PO

Fresno / Ash
7030 PO

Fresno / Ash
7039 PO

Tipología tejido con cuerda / Typology woven with rope

Opciones color cuerda / Rope colour options



2 pasadas /
double weave

4 pasadas /
quadruple weave

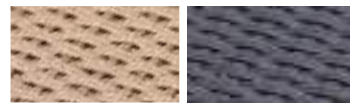

Natural

Negro / Black

Encintado / Wrapping

con cuero reciclado / with recycled leather



Aplicación /
Application

Negro

Nuit

Marrón

Cuero

Vaqueta

Encintado / Wrapping

con cuero natural plena flor / with full grain leather



Aplicación /
Application

Negro

Marrón

Coñac

Caramelo

Natural

Encintado / Wrapping

con cinta acrílica / with acrylic tape



Aplicación /
Application

Piedra

Grafito

Mineral

Integral

Tapizado / Upholstery

Textiles (poliéster y lana) / Fabrics (polyester & wool), Gabriel – Go Uni & Fame.

Piel Natural / Natural leather, Penelopeggi - Nuvola



Fame
61136

Fame
60078

Fame
61134

Fame
61060

Fame
63076

Fame
60999

Fame
60999

Fame
66061



Fame
68004

Go Uni
61138

Go Uni
60093

Go Uni
60083

Go Uni
60084

Go Uni
61144

Go Uni
60999

Go Uni
61143



Go Uni
61145

Go Uni
60081

PO141
Antracite

PO205
Notte

PO175
Bruno

PO131
Cuoió

PO151
Pesca

Cistell Collection by Yago Sarri

Modelos / Models

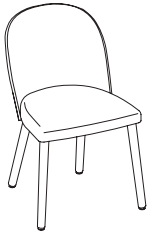

790-01

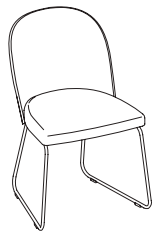

790-02

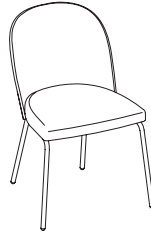

790-03

Respaldo y asiento / Backrest & seat

Respaldo contrachapado de haya, fresno o nogal acabados madera natural, tintados o lacados según material. Asiento con marco de madera con cinchas elásticas y espuma, tapizado. / Backrest beech, ash or walnut plywood finished with natural wood, stained or laquered according to material. Wooden seat with elastic straps and foam, upholstered.

Estructura / Frame

Patatas madera / Wooden legs

Patatas torneadas en madera maciza de haya o fresno/ Turned legs in solid beech or ash wood, natural wood finishes.

Peso / Weight

7,5 kg/u

Volumen caja /

Volumetric Packaging

1 u. 55 x 56 x 78 cm

Respaldo y asiento / Backrest & seat

Respaldo contrachapado de haya, fresno o nogal acabados madera natural, tintados o lacados según material. Asiento con marco de madera con cinchas elásticas y espuma, tapizado. / Backrest beech, ash or walnut plywood finished with natural wood, stained or laquered according to material. Wooden seat with elastic straps and foam, upholstered.

Estructura / Frame

Patatas acero / Metal legs

Tipo patín en varilla de acero pintada en polvo con colores RAL. / Metal rod finished powder - coated with RAL colours.

Peso / Weight

7,5 kg/u

Volumen caja /

Volumetric Packaging

1 u. 55 x 56 x 78 cm

Respaldo y asiento / Backrest & seat

Respaldo contrachapado de haya, fresno o nogal acabados madera natural, tintados o lacados según material. Asiento con marco de madera con cinchas elásticas y espuma, tapizado. / Backrest beech, ash or walnut plywood finished with natural wood, stained or laquered according to material. Wooden seat with elastic straps and foam, upholstered.

Estructura / Frame

Patatas acero / Metal legs

Patatas en tubo de acero pintado en polvo con colores RAL / legs in steel tube finished powder - coated with RAL colours.

Peso / Weight

7,5 kg/u

Volumen caja /

Volumetric Packaging

1 u. 55 x 56 x 78 cm

Medidas / Dimensions

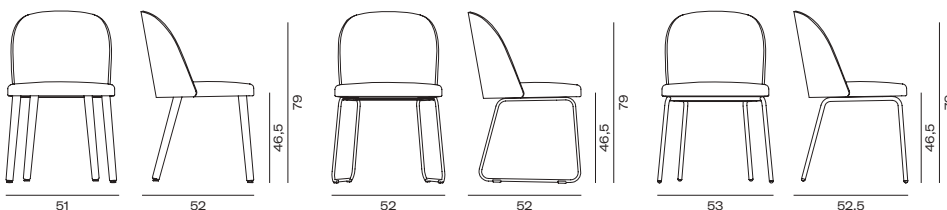

Modelos / Models

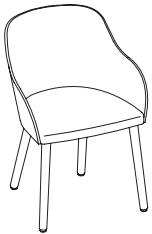

791-01

Respaldo y asiento / Backrest & seat

Respaldo contrachapado de haya, fresno o nogal acabados madera natural, tintados o lacados según material. Asiento con marco de madera con cinchas elásticas y espuma, tapizado. / Backrest beech, ash or walnut plywood finished with natural wood, stained or laquered according to material. Wooden seat with elastic straps and foam, upholstered.

Estructura / Frame

Patatas madera / Wooden legs

Patatas torneadas en madera maciza de haya o fresno/ Turned legs in solid beech or ash wood, natural wood finishes.

Peso / Weight

8 kg/u

Volumen caja / Volumetric Packaging

1 u. 55 x 56 x 78 cm

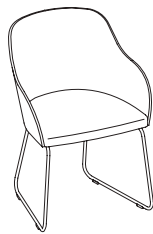

791-02

Respaldo y asiento / Backrest & seat

Respaldo contrachapado de haya, fresno o nogal acabados madera natural, tintados o lacados según material. Asiento con marco de madera con cinchas elásticas y espuma, tapizado. / Backrest beech, ash or walnut plywood finished with natural wood, stained or laquered according to material. Wooden seat with elastic straps and foam, upholstered.

Estructura / Frame

Patatas acero / Metal legs

Tipo patín en varilla de acero pintada en polvo con colores RAL. / Metal rod finished powder - coated with RAL colours.

Peso / Weight

8 kg/u

Volumen caja / Volumetric Packaging

1 u. 55 x 56 x 78 cm

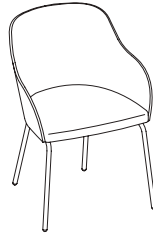

791-03

Respaldo y asiento / Backrest & seat

Respaldo contrachapado de haya, fresno o nogal acabados madera natural, tintados o lacados según material. Asiento con marco de madera con cinchas elásticas y espuma, tapizado. / Backrest beech, ash or walnut plywood finished with natural wood, stained or laquered according to material. Wooden seat with elastic straps and foam, upholstered.

Estructura / Frame

Patatas acero / Metal legs

Patatas en tubo de acero pintado en polvo con colores RAL / legs in steel tube finished powder - coated with RAL colours.

Peso / Weight

9 kg/u

Volumen caja / Volumetric Packaging

1 u. 55 x 56 x 78 cm

Medidas / Dimensions

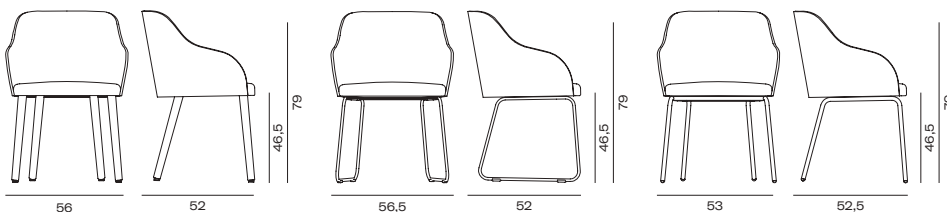

Cistell Collection by Yago Sarri

Modelos / Models

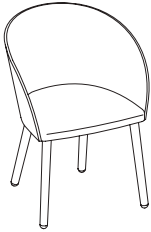

792-01

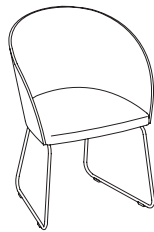

792-02

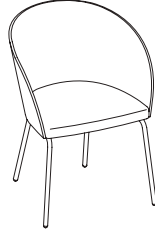

792-03

Respaldo y asiento / Backrest & seat

Respaldo y asiento / Backrest & seat

Respaldo contrachapado de haya, fresno o nogal acabados madera natural, tintados o lacados según material. Asiento con marco de madera con cinchas elásticas y espuma, tapizado. / Backrest beech, ash or walnut plywood finished with natural wood, stained or laquered according to material. Wooden seat with elastic straps and foam, upholstered.

Estructura / Frame

Patas madera / Wooden legs

Patas torneadas en madera maciza de haya o fresno/ Turned legs in solid beech or ash wood.

Peso / Weight

8 kg/u

Volumen caja / Volumetric Packaging

1 u. 55 x 56 x 78 cm

Respaldo y asiento / Backrest & seat

Respaldo contrachapado de haya, fresno o nogal acabados madera natural, tintados o lacados según material. Asiento con marco de madera con cinchas elásticas y espuma, tapizado. / Backrest beech, ash or walnut plywood finished with natural wood, stained or laquered according to material. Wooden seat with elastic straps and foam, upholstered.

Estructura / Frame

Patas acero / Metal legs

Tipo patín en varilla de acero pintada en polvo con colores RAL. / Metal rod finished powder - coated with RAL colours. Sled steel base.

Peso / Weight

8 kg/u

Volumen caja / Volumetric Packaging

1 u. 55 x 56 x 78 cm

Respaldo y asiento / Backrest & seat

Respaldo contrachapado de haya, fresno o nogal acabados madera natural, tintados o lacados según material. Asiento con marco de madera con cinchas elásticas y espuma, tapizado. / Backrest beech, ash or walnut plywood finished with natural wood, stained or laquered according to material. Wooden seat with elastic straps and foam, upholstered.

Estructura / Frame

Patas acero / Metal legs

Patas en tubo de acero pintado en polvo con colores RAL / legs in steel tube finished powder - coated with RAL colours.

Peso / Weight

9 kg/u

Volumen caja / Volumetric Packaging

1 u. 55 x 56 x 78 cm

Medidas / Dimensions

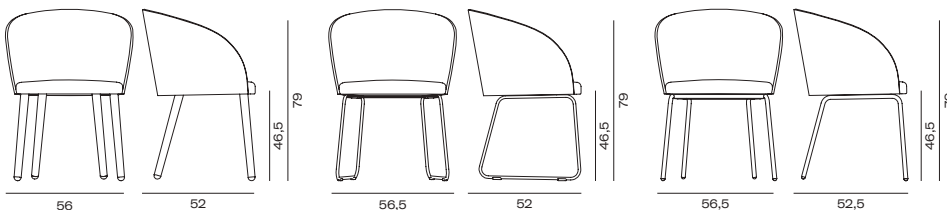

Respaldo / Backrest

Madera contrachapada / Veneer plywood.

Patas madera / Wooden Legs

Madera maciza / Solid Wood.



Tapizado / Upholstery

Textiles (lana) / Fabrics (wool), Gabriel – Select. Kvadrat – Star.

Piel Vegana (PV) / Vegan leather, Spradling – Dolce. Piel Natural / Natural leather, Penelopeoggi – Nuvola.



Estructura / Frame

Tubo de acero pintado en polvo con colores RAL. / Steel tube finished powder - coated with RAL colors.

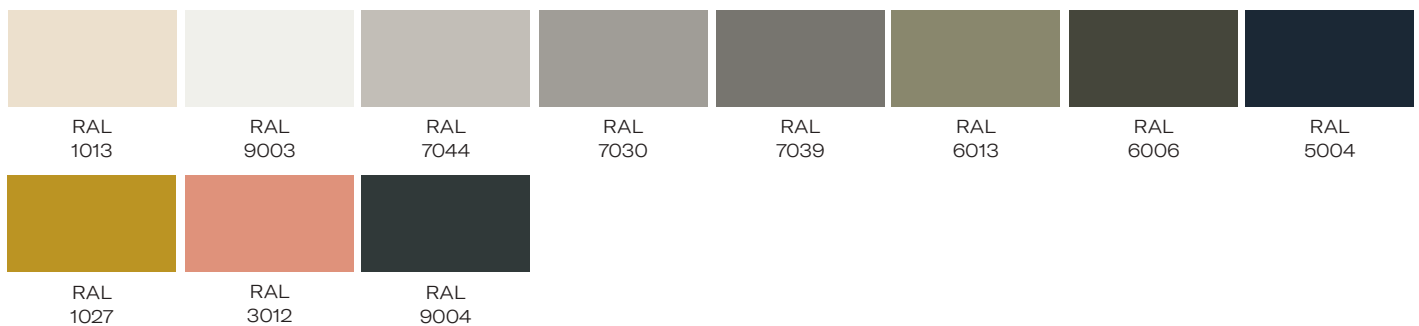

Acabados metálicos / Metal finishes

Acabados RAL / RAL finishes

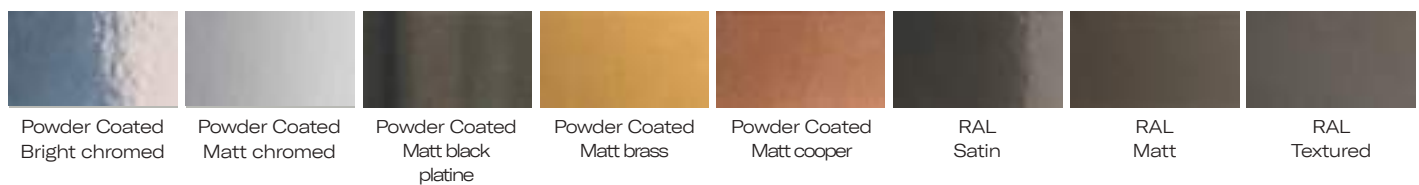

Todos los acabados que se muestran a continuación forman parte de una elaborada selección. Para ver carta completa de acabados dirigirse a pág. 184. / All finishes shown below are part of an elaborate color palette. To see the complete catalogue of finishes see page 184.

Certificados / Certificates

Modelo / Model 790-04. 1st Level EN 16139:2013.

Dula Collection by Yago Sarri

Composiciones / Compositions

1

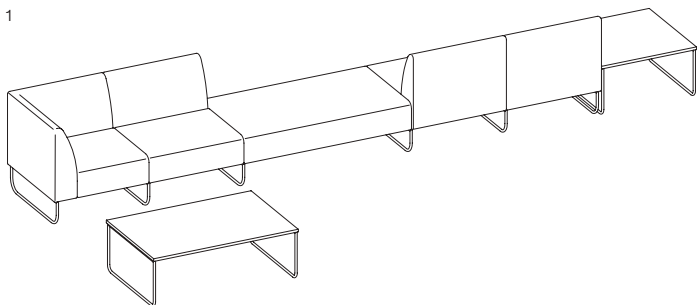

2

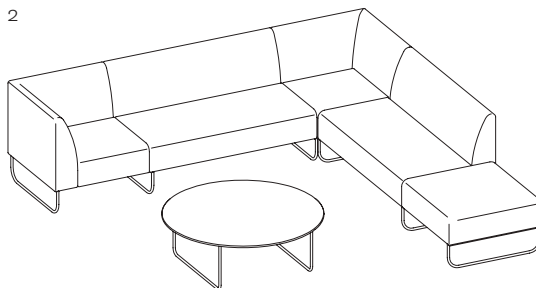

3

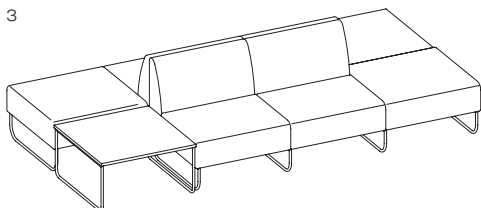

4

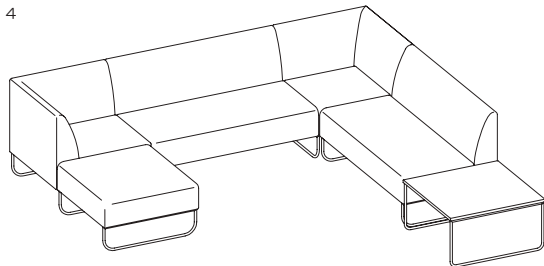

5

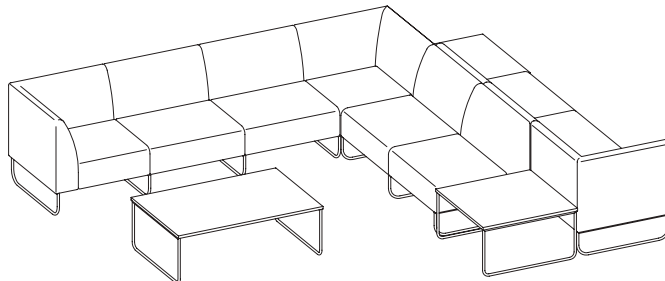

1. Sistema lineal back to back. / Linear system back to back.

2. Sistema corner L. / L corner system.

3. Isla Central. / Central Island.

4. Sistema en U. / U system.

5. Sistema corner L + back to back. / L corner system + back to back.

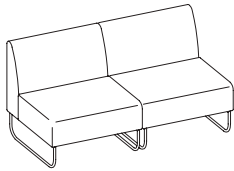
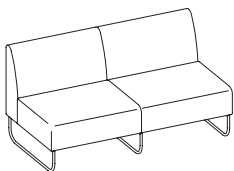

Módulos con conector de patas compartidas. / Modules with shared legs connector.

Módulos independientes. / Independent modules.

Modelos / Models



340-01

Respaldo y asiento / Backrest & seat

Estructura en madera contrachapada con espuma y tapizada. Asiento con cinchas elásticas. / Frame in plywood with foam and upholstered. Seat with elastic straps.

Estructura / Frame Patas acero / Metal legs

4 patas en tubo de acero pintado en polvo con colores RAL. / 4 legs in steel tube finished powder - coated with RAL colours.

Peso / Weight

18 kg/u

Volumen caja / Volumetric Packaging

1 u. 74 x 73 x 75 cm

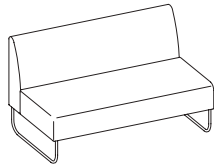

342-01

Respaldo y asiento / Backrest & seat

Estructura en madera contrachapada con espuma y tapizada. Asiento con cinchas elásticas. / Frame in plywood with foam and upholstered. Seat with elastic straps.

Estructura / Frame Patas acero / Metal legs

4 patas en tubo de acero pintado en polvo con colores RAL. / 4 legs in steel tube finished powder - coated with RAL colours.

Peso / Weight

36 kg/u

Volumen caja / Volumetric Packaging

1 u. 127 x 72 x 70 cm

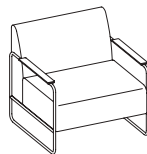

340-02

Respaldo y asiento / Backrest & seat

Estructura en madera contrachapada con espuma y tapizada. / Frame in plywood with foam and upholstered.

Estructura / Frame Patas acero / Metal legs

Patas en tubo de acero pintado en polvo con colores RAL.

Reposabrazos en madera maciza de haya o roble, acabados madera natural, tintados o lacados según material. / Legs in steel tube finished powder - coated with RAL colours. Armrests in solid beech or oak wood, natural wood finishes, tinted or lacquered according to material.

Peso / Weight

21 kg/u

Volumen caja / Volumetric Packaging

1 u. 74 x 80 x 73,5 cm

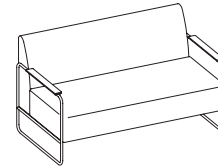

342-02

Respaldo y asiento / Backrest & seat

Estructura en madera contrachapada con espuma y tapizada. / Frame in plywood with foam and upholstered.

Estructura / Frame Patas acero / Metal legs

Patas en tubo de acero pintado en polvo con colores RAL.

Reposabrazos en madera maciza de haya o roble, acabados madera natural, tintados o lacados según material. / Legs in steel tube finished powder - coated with RAL colours. Armrests in solid beech or oak wood, natural wood finishes, tinted or lacquered according to material.

Peso / Weight

36 kg/u

Volumen caja / Volumetric Packaging

1 u. 134 x 72 x 74 cm

Medidas / Dimensions

340-01

342-01

340-02

342-02

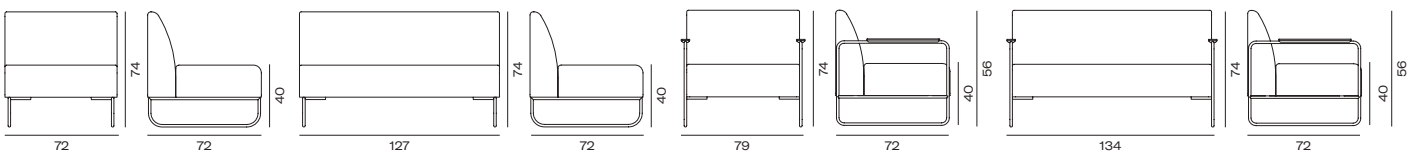

Dula Collection by Yago Sarri

Modelos / Models

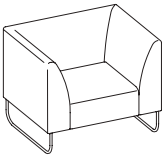

341-01

Respaldo y asiento / Backrest & seat

Estructura en madera contrachapada con espuma y tapizada. Asiento con cinchas elásticas. / Frame in plywood with foam and upholstered. Seat with elastic straps.

Estructura / Frame Patas acero / Metal legs

4 patas en tubo de acero pintado en polvo con colores RAL. / 4 legs in steel tube finished powder - coated with RAL colours.

Peso / Weight

32,5 kg/u

Volumen caja / Volumetric Packaging

1 u. 74 x 90 x 74 cm

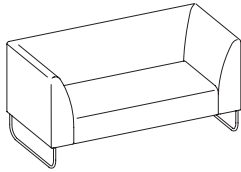

343-01

Respaldo y asiento / Backrest & seat

Estructura en madera contrachapada con espuma y tapizada. Asiento con cinchas elásticas. / Frame in plywood with foam and upholstered. Seat with elastic straps.

Estructura / Frame Patas acero / Metal legs

4 patas en tubo de acero pintado en polvo con colores RAL. / 4 legs in steel tube finished powder - coated with RAL colours.

Peso / Weight

45 kg/u

Volumen caja / Volumetric Packaging

1 u. 150 x 72 x 74 cm

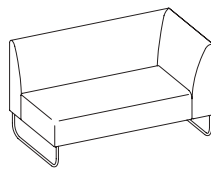

349-01

Respaldo y asiento / Backrest & seat

Estructura en madera contrachapada con espuma y tapizada. Asiento con cinchas elásticas. / Frame in plywood with foam and upholstered. Seat with elastic straps.

Estructura / Frame Patas acero / Metal legs

4 patas en tubo de acero pintado en polvo con colores RAL. / 4 legs in steel tube finished powder - coated with RAL colours.

Peso / Weight

30 kg/u

Volumen caja / Volumetric Packaging

1 u. 127 x 73 x 42 cm

Medidas / Dimensions

341-01

343-01

349-01

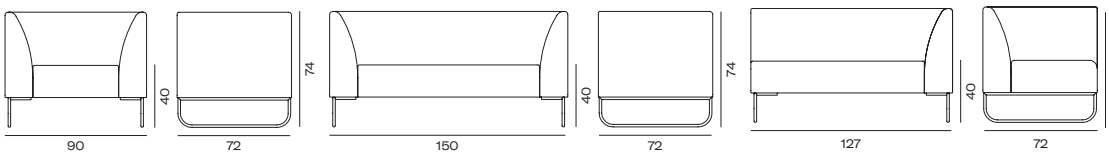

Modelos / Models

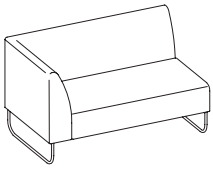

350-01

Respaldo y asiento / Backrest & seat

Estructura en madera contrachapada con espuma y tapizada. Asiento con cinchas elásticas. / Frame in plywood with foam and upholstered. Seat with elastic straps.

Estructura / Frame Patatas acero / Metal legs

4 patas en tubo de acero pintado en polvo con colores RAL. / 4 legs in steel tube finished powder - coated with RAL colours.

Peso / Weight
30 kg/u

**Volumen caja /
Volumetric Packaging**
1 u. 127 x 72 x 74 cm

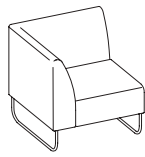

345-01

Respaldo y asiento / Backrest & seat

Estructura en madera contrachapada con espuma y tapizada. Asiento con cinchas elásticas. / Frame in plywood with foam and upholstered. Seat with elastic straps.

Estructura / Frame Patatas acero / Metal legs

4 patas en tubo de acero pintado en polvo con colores RAL. / 4 legs in steel tube finished powder - coated with RAL colours.

Peso / Weight
23 kg/u

**Volumen caja /
Volumetric Packaging**
1 u. 73 x 72 x 74 cm

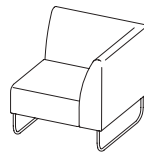

345-02

Respaldo y asiento / Backrest & seat

Estructura en madera contrachapada con espuma y tapizada. Asiento con cinchas elásticas. / Frame in plywood with foam and upholstered. Seat with elastic straps.

Estructura / Frame Patatas acero / Metal legs

4 patas en tubo de acero pintado en polvo con colores RAL. / 4 legs in steel tube finished powder - coated with RAL colours.

Peso / Weight
23 kg/u

**Volumen caja /
Volumetric Packaging**
1 u. 73 x 72 x 74 cm

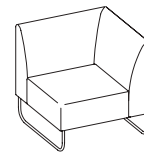

344-01

Respaldo y asiento / Backrest & seat

Estructura en madera contrachapada con espuma y tapizada. Asiento con cinchas elásticas. / Frame in plywood with foam and upholstered. Seat with elastic straps.

Estructura / Frame Patatas acero / Metal legs

4 patas en tubo de acero pintado en polvo con colores RAL. / 4 legs in steel tube finished powder - coated with RAL colours.

Peso / Weight
23 kg/u

**Volumen caja /
Volumetric Packaging**
1 u. 73 x 73 x 74 cm

Medidas / Dimensions

350-01

345-01

345-02

344-01

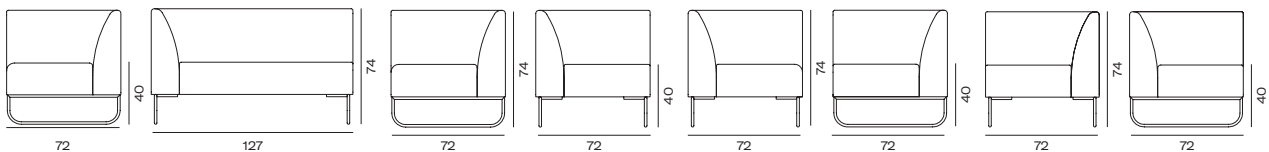

Dula Collection by Yago Sarri

Modelos / Models

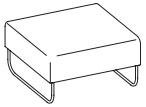

346-01

Asiento / seat

Estructura en madera contrachapada con espuma y tapizada. Asiento con cinchas elásticas. / Frame in plywood with foam and upholstered. Seat with elastic straps.

Estructura / Frame Patatas acero / Metal legs

4 patas en tubo de acero pintado en polvo con colores RAL. / 4 legs in steel tube finished powder - coated with RAL colours.

Peso / Weight

13 kg/u

Volumen caja / Volumetric Packaging

1 u. 73 x 73 x 42 cm

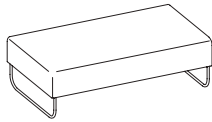

347-01

Asiento / seat

Estructura en madera contrachapada con espuma y tapizada. Asiento con cinchas elásticas. / Frame in plywood with foam and upholstered. Seat with elastic straps.

Estructura / Frame Patatas acero / Metal legs

4 patas en tubo de acero pintado en polvo con colores RAL. / 4 legs in steel tube finished powder - coated with RAL colours.

Peso / Weight

17,5 kg/u

Volumen caja / Volumetric Packaging

1 u. 127 x 73 x 42 cm



348-01



348-02

Cojín / Cushion

Cojín con relleno de fibra, tapizado con cremallera inferior. / Cushion with fiber stuffing, upholstered with bottom zipper.

Peso / Weight

0,5 kg/u

Volumen caja / Volumetric Packaging

1 u. 50 x 50 x 20 cm

Medidas / Dimensions

346-01

347-01

348-01

348-02

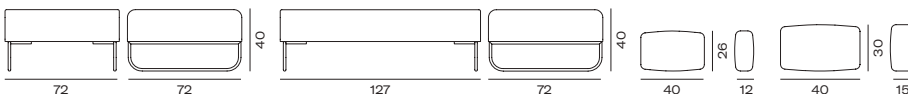

Tapizado / Upholstery

Textiles / Fabrics, Gabriel – Harmony & Frame.

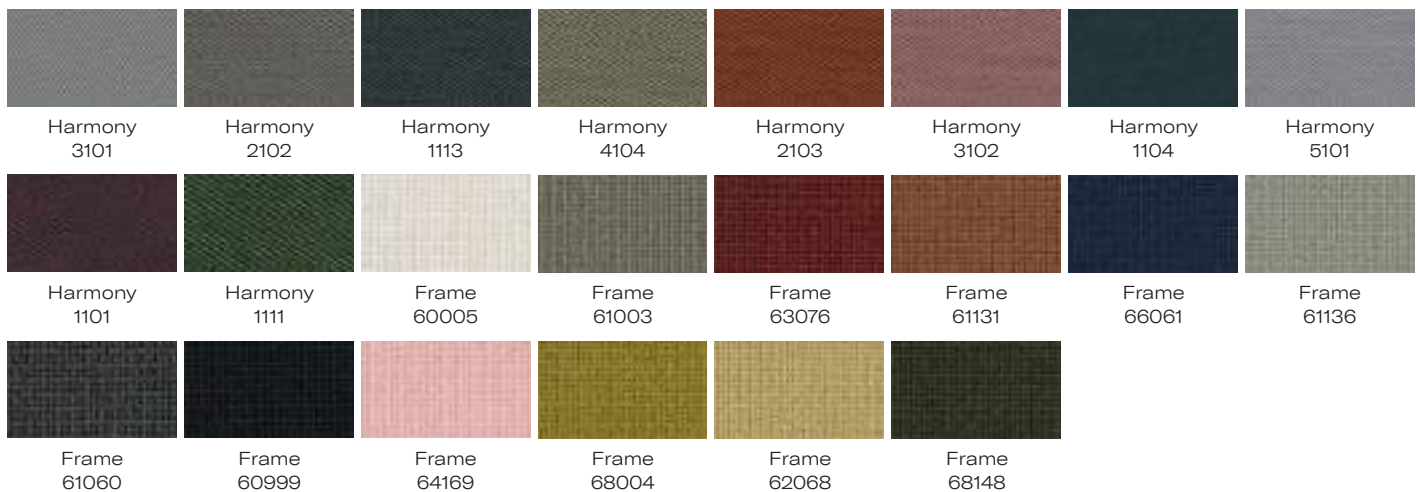

Estructura / Frame

Patas acero / Metal legs

Acero pintado en polvo con colores RAL. / Steel finished powder - coated with RAL colors.



Acabados metálicos / Metal finishes

Acabados RAL / RAL finishes



Reposabrazos / Armrests

Rechapado de madera. / Wooden veneer.

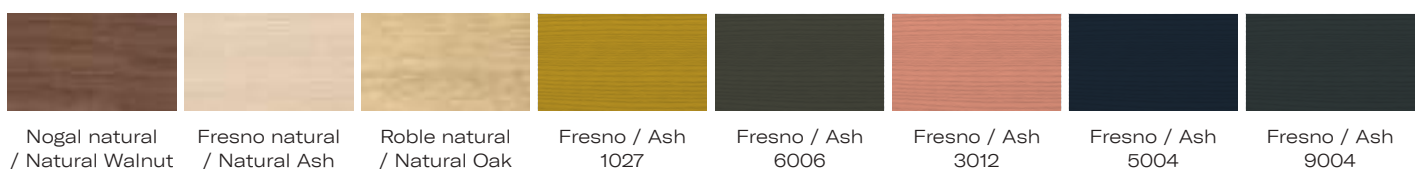

Todos los acabados que se muestran a continuación forman parte de una elaborada selección. Para ver carta completa de acabados dirigirse a pág. 184. / All finishes shown below are part of an elaborate color palette. To see the complete catalogue of finishes see page 184.

Dula Collection by Yago Sarri

Modelos / Models

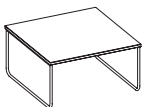

338-01

Sobre / Top

Sobre de 72 x 72 x 2 cm, en madera chapada y canteada de haya, fresno, roble o nogal acabados madera natural, tintados o lacados según material. MDF lacado, laminado Infinity, Silestone o Dekton. / Top of 72 x 72 x 2 cm, in veneer and tinted wood of beech, ash, oak or walnut finishes natural wood, tinted or lacquered according to material. Lacquered MDF, Infinity laminate, Silestone or Dekton.

Estructura / Frame

Patatas acero / Metal legs

Patatas en tubo de acero pintado en polvo con colores RAL. / Legs in steel tube finished powder, coated with RAL colours.

Peso / Weight

7 kg/u

Volumen caja / Volumetric Packaging

1 u. 72 x 72 x 38 cm

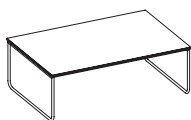

338-02

Sobre / Top

Sobre de 110 x 72 x 2 cm, en madera chapada y canteada de haya, fresno, roble o nogal acabados madera natural, tintados o lacados según material. MDF lacado, laminado Infinity, Silestone o Dekton. / Top of 110 x 72 x 2cm, in veneer and tinted wood of beech, ash, oak or walnut finishes natural wood, tinted or lacquered according to material. Lacquered MDF, Infinity laminate, Silestone or Dekton.

Estructura / Frame

Patatas acero / Metal legs

Patatas en tubo de acero pintado en polvo con colores RAL. / Legs in steel tube finished powder, coated with RAL colours.

Peso / Weight

11 kg/u

Volumen caja / Volumetric Packaging

1 u. 110 x 72 x 38 cm

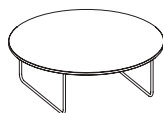

338-03

Sobre / Top

Sobre de Ø 110x 2 cm, en madera chapada y canteada de haya, fresno, roble o nogal acabados madera natural, tintados o lacados según material. MDF lacado, laminado Infinity, Silestone o Dekton. / Top of 72 x 72 x 2 cm, in veneer and tinted wood of beech, ash, oak or walnut finishes natural wood, tinted or lacquered according to material. Lacquered MDF, Infinity laminate, Silestone or Dekton.

Estructura / Frame

Patatas acero / Metal legs

Patatas en tubo de acero pintado en polvo con colores RAL. / Legs in steel tube finished powder, coated with RAL colours.

Peso / Weight

9 kg/u

Volumen caja / Volumetric Packaging

1 u. 110 x 110 x 38 cm

Medidas / Dimensions

338-01

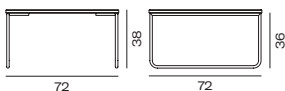

338-02

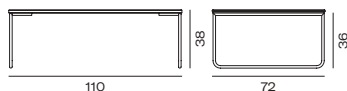

338-03

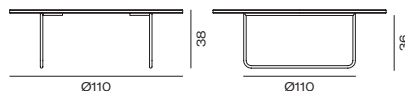

Sobre madera / Wooden Top

Madera de nogal, fresno y roble natural. / Wooden natural walnut, ash & oak.



Sobre Dekton / Dekton top



Sobre silestone / Silestone top



Sobre Formica / Formica top

Laminado HPL. / HPL laminate.



Estructura / Frame

Patas acero / Metal legs



Acabados metálicos / Metal finishes

Acabados RAL / RAL finishes



Glöwr Collection by Claire Davies

Modelos / Models

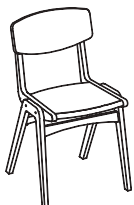

780

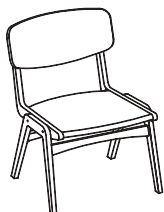

781



782

Respaldo y asiento / Backrest & seat

Contrachapado de haya.
Disponibile en madera
natural o tintada.
/ Plywood beech.
Available in natural wood
or dye.

Patas madera / Wooden legs

Madera maciza de haya
acabados natural o tinte.
Fijación lateral con
tornillos de latón. / Solid
beech wood. Available in
natural wood, dye or
lacquer. Lateral fixation
with brass screws.

Tapizado / Upholstery

Tapizado de asiento, o
en el conjunto de asiento
y respaldo. / Upholstered
seat or seat and backrest.

Peso / Weight

5 kg/u

Volumen caja / Volumetric Packaging

2 u. 49 x 59 x 97 cm

Apilable* / Stackable*

Hasta 5 u / Up to 5 u
*Excepto las tapizadas.
/ *Except upholstered.

Respaldo y asiento / Backrest & seat

Contrachapado de haya.
Disponibile en madera
natural o tintada.
/ Plywood beech.
Available in natural wood
or dye.

Patas madera / Wooden legs

Madera maciza de haya
acabados natural o tinte.
Fijación lateral con
tornillos de latón. / Solid
beech wood. Available in
natural wood, dye or
lacquer. Lateral fixation
with brass screws.

Tapizado / Upholstery

Tapizado de asiento, o
en el conjunto de asiento
y respaldo. / Upholstered
seat or seat and backrest.

Peso / Weight

7,5 kg/u

Volumen caja / Volumetric Packaging

2 u. 58 x 68 x 89 cm

Apilable* / Stackable*

Hasta 5 u / Up to 5 u
*Excepto las tapizadas.
/ *Except upholstered.

Respaldo y asiento / Backrest & seat

Contrachapado de haya.
Disponibile en madera
natural o tintada.
/ Plywood beech.
Available in natural wood
or dye.

Patas madera / Wooden legs

Madera maciza de haya
acabados natural o tinte.
Fijación lateral con
tornillos. Reposapiés
metálico acabado en
latón. / Solid beech
wood. Available in natural
wood, dye or lacquer.
Lateral fixation with brass
screws. Metallic footrest
finished in brass.

Tapizado / Upholstery

Tapizado de asiento, o
en el conjunto de asiento
y respaldo. / Upholstered
seat or seat and backrest.

Peso / Weight

6 kg/u

Volumen caja / Volumetric Packaging

1 u. 45 x 52 x 115 cm

Medidas / Dimensions

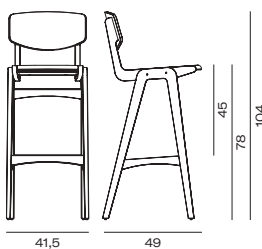
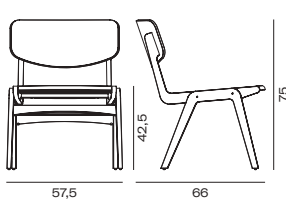
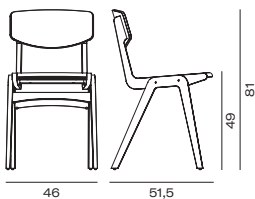

Respaldo y asiento / Backrest & seat
Madera contrachapada. / Veneer plywood.

Patas madera / Wooden legs
Madera maciza. / Solid Wood.



Tapizado / Upholstery

Textiles (poliéster y lana) / Fabrics (polyester & wool), Gabriel – Go Uni & Fame.

Piel Vegana (PV) / Vegan leather, Spradling – Dolce. Piel Natural / Natural leather, Penelopeoggi – Nuvola Pesca.

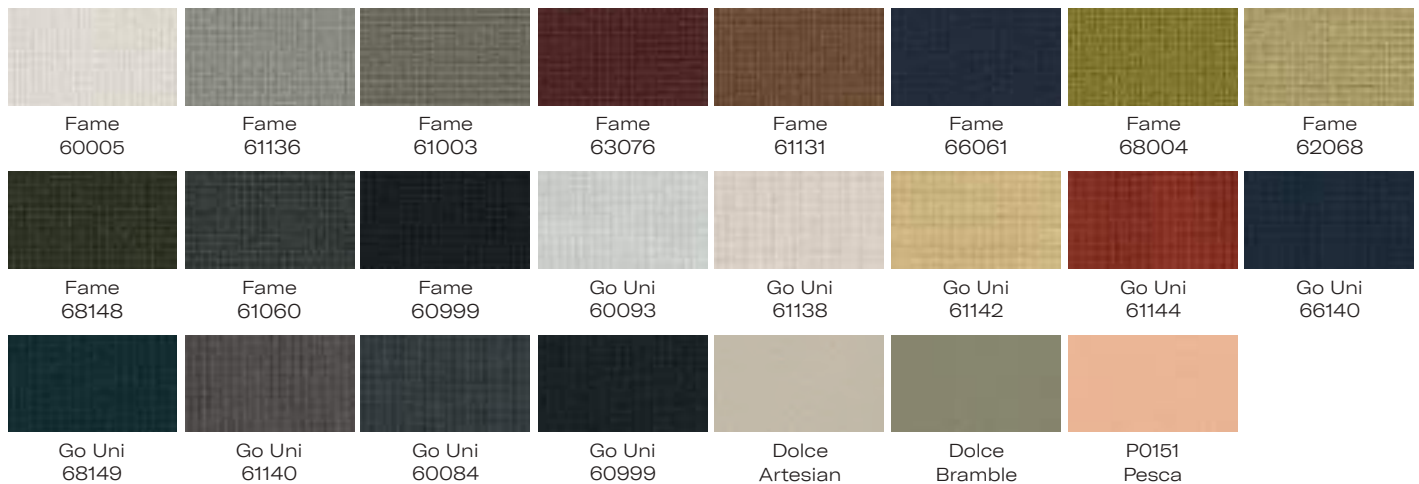

Todos los acabados que se muestran a continuación forman parte de una elaborada selección. Para ver carta completa de acabados dirigirse a pág. 184. / All finishes shown below are part of an elaborate color palette. To see the complete catalogue of finishes see page 184.

Certificados / Certificates

Modelos / Models 780 – 782. EN 1728:2012 + AC:2013.

Glöwr Collection by Claire Davies

Modelos / Models

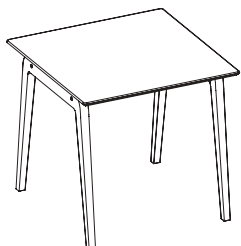

783

Sobre / Top

Contrachapado de haya.
Disponibile en madera
natural, tinte o Formica
Infiniti. / Plywood beech.
Available in natural wood,
dye or Formica Infiniti.

Base madera / Wooden base

Madera maciza de haya
acabados natural
o tinte. Fijación lateral
con tornillos de latón.
/ Solid beech wood
finished natural or dye.
Lateral fixation with
brass screws.

Peso / Weight

16,5 kg/u

Volumen caja /

Volumetric Packaging

1 u. 82 x 82 x 80 cm

Medidas / Dimensions

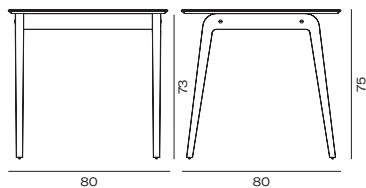

Sobre madera / Wooden Top

Rechapado de madera. / Wooden veneer.



Sobre Formica / Formica top

Laminado HPL. / HPL laminate.

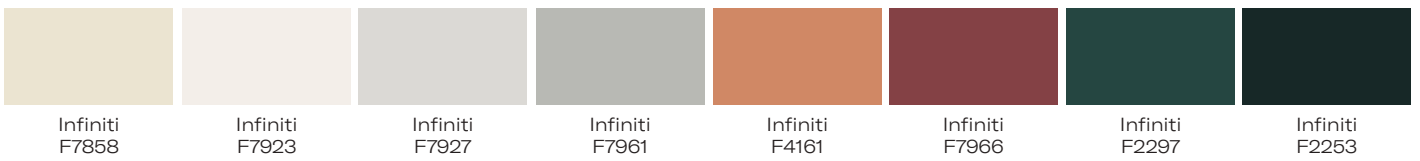

Estructura madera / Wooden frame

Madera maciza de haya. / Solid beech wood.

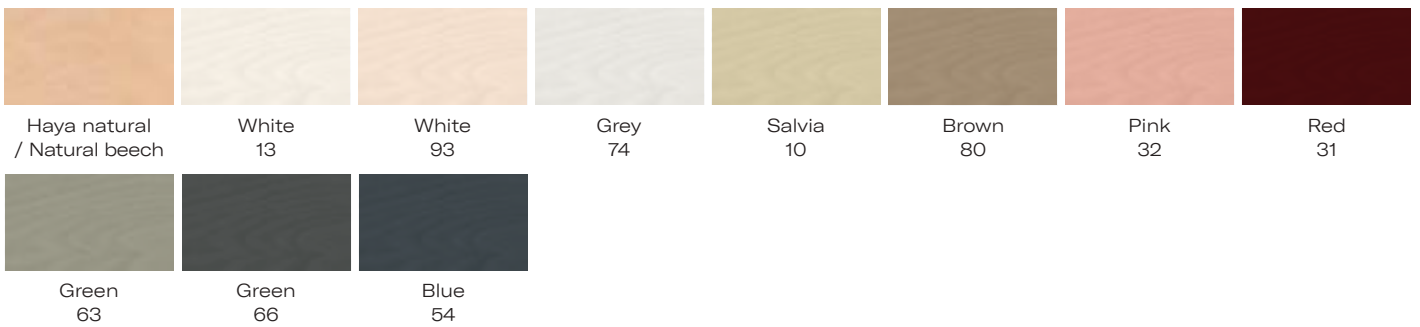

Kimmi Collection by Roger Vancells

Modelos / Models



253



254



255



256

Respaldo y asiento / Backrest & seat

Contrachapado de haya o fresno acabados madera natural, haya tintada y fresno lacado. / Beech or Ash Plywood Finishes in natural wood, dye beech and lacquered ash.

Estructura / Frame Patatas acero / Metal legs

Tubo de acero pintado en polvo con colores RAL. / Steel tube finished powder - coated with RAL colors.

Tapizado / Upholstery

Tapizado disponible en asiento. / Upholstery available in seat.

Peso / Weight

5 kg/u

Volumen caja / Volumetric Packaging

1 u. 49 x 59 x 97 cm

Respaldo y asiento / Backrest & seat

Contrachapado de haya o fresno acabados madera natural, haya tintada y fresno lacado. / Beech or Ash Plywood Finishes in natural wood, dye beech and lacquered ash.

Estructura / Frame Patatas acero / Metal legs

Varilla de acero pintado en polvo con colores RAL. Pata tipo patin con deslizantes. / Steel rod finished powder - coated with RAL colors. Sled steel base.

Tapizado / Upholstery

Tapizado disponible en asiento. / Upholstery available in seat.

Peso / Weight

7 kg/u

Volumen caja / Volumetric Packaging

1 u. 49 x 59 x 97 cm

Respaldo y asiento / Backrest & seat

Contrachapado de haya o fresno acabados madera natural, haya tintada y fresno lacado. / Beech or Ash Plywood Finishes in natural wood, dye beech and lacquered ash.

Estructura / Frame Patatas acero / Metal legs

Tubo de acero pintado en polvo con colores RAL. Pata tipo araña giratoria con reguladores. / Steel tube finished powder - coated with RAL colors. Swivel central base.

Tapizado / Upholstery

Tapizado disponible en asiento. / Upholstery available in seat.

Peso / Weight

10 kg/u

Volumen caja / Volumetric Packaging

1 u. 49 x 59 x 97 cm

Respaldo y asiento / Backrest & seat

Contrachapado de haya o fresno acabados madera natural, haya tintada y fresno lacado. / Beech or Ash Plywood Finishes in natural wood, dye beech and lacquered ash.

Estructura / Frame Patatas acero / Metal legs

Marco de acero pintado en polvo con colores RAL. / Steel frame finished powder - coated with RAL colors.

Patatas madera / Wooden legs

Patatas de madera maciza de haya o fresno. / Beech or ash solid wood legs.

Tapizado / Upholstery

Tapizado disponible en asiento. / Upholstery available in seat.

Peso / Weight

6,5 kg/u

Volumen caja / Volumetric Packaging

1 u. 49 x 59 x 97 cm

Medidas / Dimensions

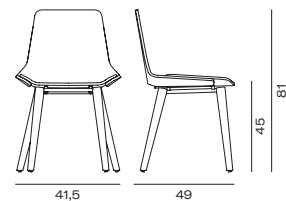
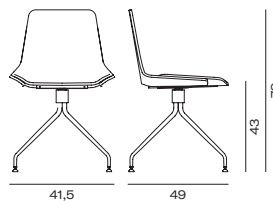
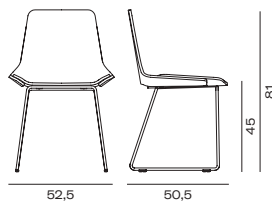
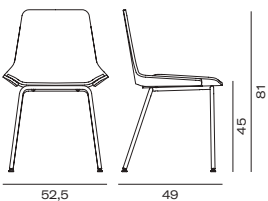

Respaldo y asiento / Backrest & seat
Madera contrachapada. / Veneer plywood.

Patas madera / Wooden legs
Madera maciza. / Solid Wood.

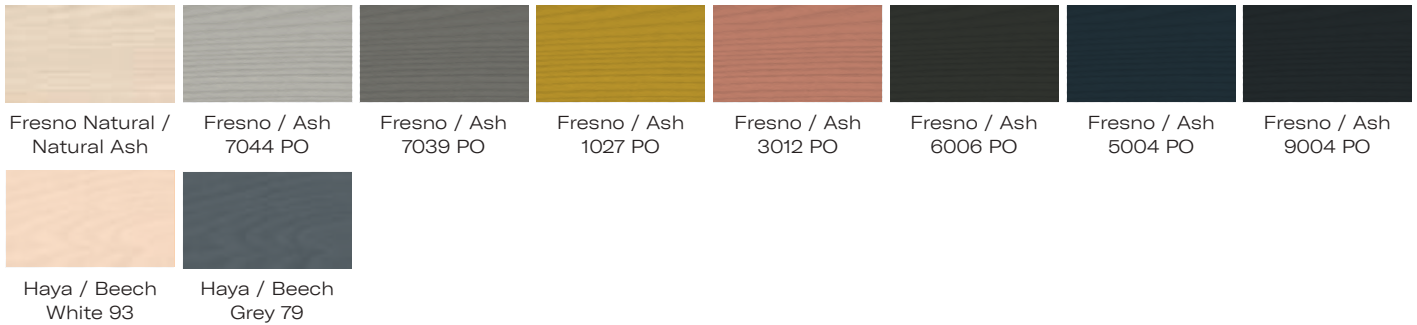

Estructura / Frame

Patas acero / Metal legs

Acero pintado en polvo con colores RAL. / Steel finished powder - coated with RAL colors.

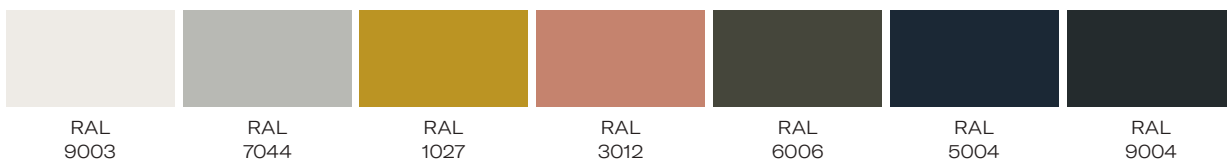

Acabados metálicos / Metal finishes

Acabados RAL / RAL finishes



Tapizado / Upholstery

Textiles (poliéster) / Fabrics (polyester), Gabriel – Atlantic. Piel Vegana (PV) / Vegan leather, Spradling – Dolce.



Todos los acabados que se muestran a continuación forman parte de una elaborada selección. Para ver carta completa de acabados dirigirse a pág. 184. / All finishes shown below are part of an elaborate color palette. To see the complete catalogue of finishes see page 184.

Certificados / Certificates

Modelo / Model 254. EN 1728:2012 + AC:2013

Kimmi Collection by Roger Vancells

Modelos / Models



257

Estructura y Marco del sobre / Structure & Top's frame

Base tubular en acero pintado con pintura en polvo poliéster en colores RAL. Sobre máximo aconsejado de Ø 60 cm. / 4 patas con niveladores ajustables. / Tubularbase steel polyester powder coating in RAL colors. Top recommended maximum of Ø 60 cm. 4 legs with adjustable levelers.

Peso / Weight
5,5 kg/u

Volumen caja / Volumetric Packaging
1 u. 45 x 45 x 55 cm



258

Estructura y Marco del sobre / Structure & Top's frame

Base tubular en acero pintado con pintura en polvo poliéster en colores RAL. Sobre máximo aconsejado de Ø 70 cm. / 4 patas con niveladores ajustables. / Tubularbase steel polyester powder coating in RAL colors. Top recommended maximum of Ø 70 cm. 4 legs with adjustable levelers.

Peso / Weight
8 kg/u

Volumen caja / Volumetric Packaging
1 u. 45 x 45 x 75 cm

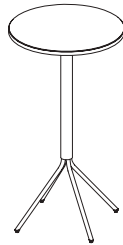

259

Estructura y Marco del sobre / Structure & Top's frame

Base tubular en acero pintado con pintura en polvo poliéster en colores RAL. Sobre máximo aconsejado de Ø 50 cm. / 4 patas con niveladores ajustables. / Tubularbase steel polyester powder coating in RAL colors. Top recommended maximum of Ø 50 cm. 4 legs with adjustable levelers.

Peso / Weight
8 kg/u

Volumen caja / Volumetric Packaging
1 u. 45 x 45 x 110 cm



260

Sobre / Top
Ø 50 – 60 – 70 cm.
MDF chapados en fresno lacado, haya tintada o laminados, o mineral de Dekton, Formica o Silestone. / MDF plated lacquered ash, dyed beech or plateds, Formica laminated or mineral Dekton, Formica or Silestone.

Marco del sobre / Top's frame
Marco de acero cromado o pintado al polvo con colores RAL. / Top's frame steel chromed or powder coated steel with RAL colors.

Peso / Weight
Segun medidas y acabados. / Depending on size & finish.

Volumen caja / Volumetric Packaging
1 u. Ø 50 = 52 x 52 x 2,5 cm
1 u. Ø 60 = 62 x 62 x 2,5 cm
1 u. Ø 70 = 72 x 72 x 2,5 cm

Medidas / Dimensions

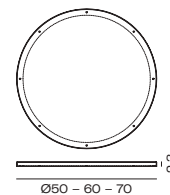
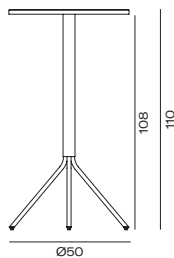
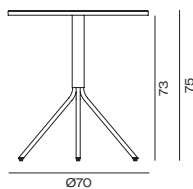
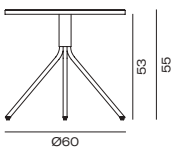

Sobre madera / Wooden top

Rechapado de madera. / Wooden veneer.

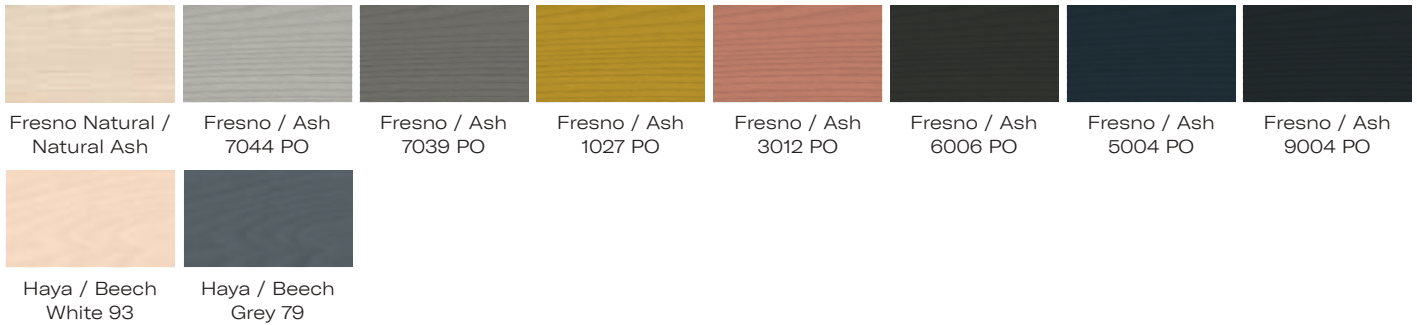

Sobre Dekton / Dekton top



Sobre silestone / Silestone top

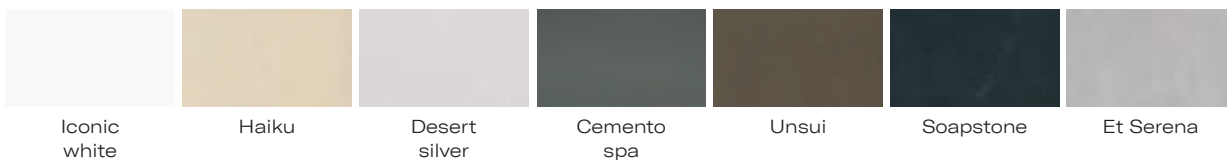

Sobre Formica / Formica top

Laminado HPL. / HPL laminate.

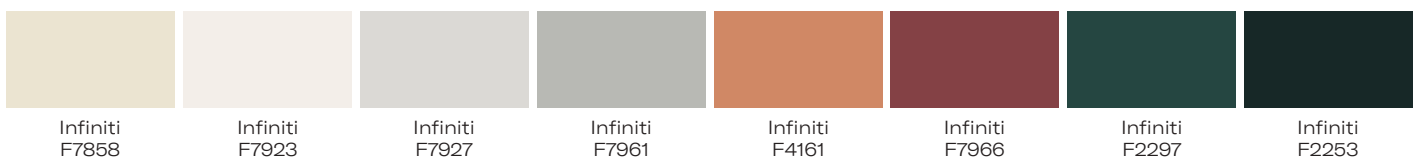

Marco y base metálica / Metal frame & base

Acero pintado en polvo con colores RAL. / Steel finished powder - coated with RAL colors.

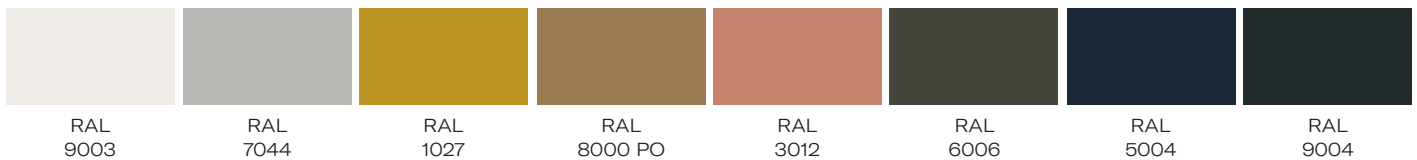

Acabados metálicos / Metal finishes

Acabados RAL / RAL finishes



Mim Collection

by Tarruella Trenchs Studio

Modelos / Models

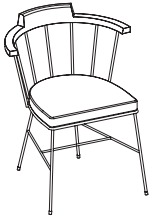

754

Respaldo / Backrest

Respaldo de madera maciza de haya tintada o lacada, nogal natural y roble natural. / Dye or lacquered beech, natural walnut and oak solid wood backrest.

Estructura / Frame

Estructura de varilla maciza de acero pintado en polvo con colores RAL. / Solid frame of steel finished powder - coated with RAL colors.

Tapizado / Upholstery

Asiento tapizado desenfundable con cremallera posterior. / Upholstered cushioned seat removable with back zip.

Peso / Weight

7 kg/u

Volumen caja /

Volumetric Packaging

1 u. 58 x 68 x 89 cm



755

Respaldo / Backrest

Respaldo de madera maciza de haya tintada o lacada, nogal natural y roble natural. / Dye or lacquered beech, natural walnut and oak solid wood backrest.

Estructura / Frame

Estructura de varilla maciza de acero pintado en polvo con colores RAL. / Solid frame of steel finished powder - coated with RAL colors.

Tapizado / Upholstery

Asiento tapizado desenfundable con cremallera posterior. / Upholstered cushioned seat removable with back zip.

Peso / Weight

9,5 kg/u

Volumen caja /

Volumetric Packaging

1 u. 49 x 59 x 97 cm



756

Respaldo / Backrest

Respaldo de madera maciza de haya tintada o lacada, nogal natural y roble natural. / Dye or lacquered beech, natural walnut and oak solid wood backrest.

Estructura / Frame

Estructura de varilla maciza de acero pintado en polvo con colores RAL. / Solid frame of steel finished powder - coated with RAL colors.

Tapizado / Upholstery

Asiento tapizado desenfundable con cremallera posterior. / Upholstered cushioned seat removable with back zip.

Peso / Weight

8,5 kg/u

Volumen caja /

Volumetric Packaging

1 u. 49 x 59 x 97 cm

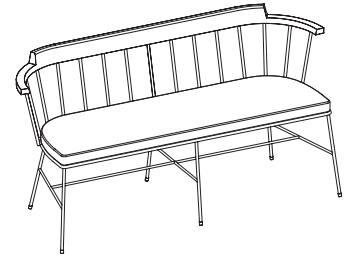

757

Respaldo / Backrest

Respaldo de madera maciza de haya tintada o lacada, nogal natural y roble natural. / Dye or lacquered beech, natural walnut and oak solid wood backrest.

Estructura / Frame

Estructura de varilla maciza de acero pintado en polvo con colores RAL. / Solid frame of steel finished powder - coated with RAL colors.

Tapizado / Upholstery

Asiento tapizado desenfundable con cremallera posterior. Este modelo cuenta con cojines (opcionales) con la misma tapicería. / Upholstered cushioned seat removable with back zip.

Peso / Weight

20 kg/u

Volumen caja /

Volumetric Packaging

1 u. 152 x 60 x 75 cm

Medidas / Dimensions

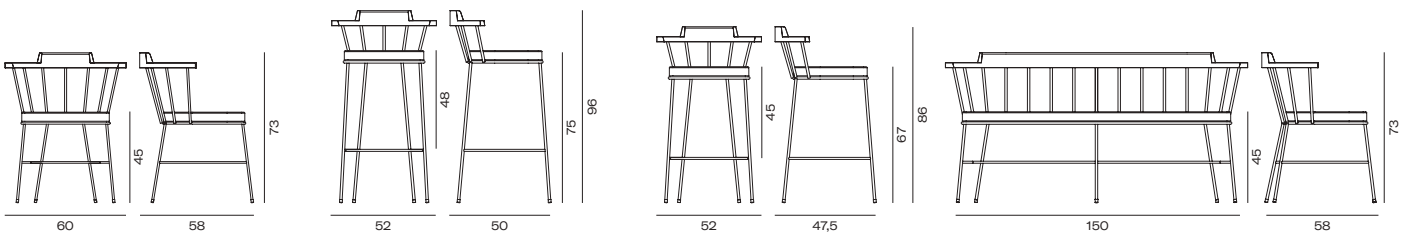

Respaldo / Backrest

Madera maciza. / Solid wood.



Estructura / Frame

Barra de acero pintado en polvo con colores RAL. / Steel finished powder - coated with RAL colors.

Patatas acero / Metal legs

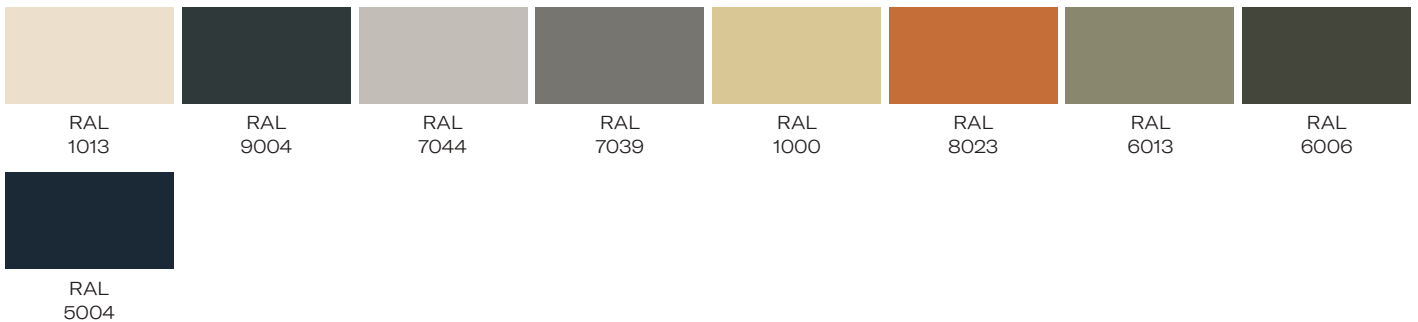

Tapizado / Upholstery

Textiles (Trevira cs) / Fabrics (Trevira cs), Gabriel – Go Check. Textiles (PP-PES) / Fabrics (PP-PES), Crevin – Dolce.



Todos los acabados que se muestran a continuación forman parte de una elaborada selección. Para ver carta completa de acabados dirigirse a pág. 184. / All finishes shown below are part of an elaborate color palette. To see the complete catalogue of finishes see page 184.

Mim Collection

by Tarruella Trenchs Studio

Modelos / Models



762

Sobre / Top
 Ø 40 – 50 cm.

Estructura / Frame
 3 patas. Varilla metálica, pintada con pintura en polvo poliéster en colores RAL. / 3 legs. Metal rod Ø 10 mm, polyester powder coating in RAL colors.

Peso / Weight
 3 kg/u – Estructura / Frame

Volumen caja / Volumetric Packaging
 1 u. 35 x 40 x 45 cm



763

Sobre / Top
 763. Ø 50 – 60 cm.
 764. Ø 60 – 70 cm.

Estructura / Frame
 3 – 4 patas. Varilla metálica, pintada con pintura en polvo poliéster en colores RAL. / 3 – 4 legs. Metal rod Ø 10 mm, polyester powder coating in RAL colors.

Peso / Weight
 763. 4,5 kg/u
 764. 7 kg/u
 Estructura /Frame

Volumen caja / Volumetric Packaging
 763. 1 u. 42 x 48 x 65 cm
 764. 1 u. 48 x 48 x 65 cm



764



765

Sobre / Top
 Sobre máximo aconsejado/ Top recommended 70x70 – 80x80 / Ø90 – Ø100.

Estructura / Frame
 4 patas. Tubo metálico, pintada con pintura en polvo poliéster en colores RAL. / 4 legs. Metal tube, polyester powder coating in RAL colors.

Peso / Weight
 7 kg/u – Estructura / Frame

Volumen caja / Volumetric Packaging
 1 u. 57 x 57 x 75 cm

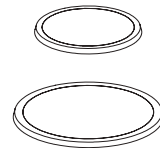

758

Sobre / Top
 Mineral de Dekton, Silestone o laminado de Formica emmarcado en madera maciza de haya natural, tintada o lacada, roble natural y nogal natural. / Dekton, silestone mineral top or laminated Formica top in natural, dyed or lacquered beech solid wood, natural oak & natural walnut solid wood.

Peso / Weight
 Segun medidas y acabados. / Depending on size & finish.

Medidas / Dimensions

762

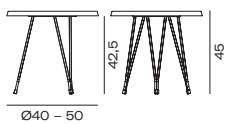

763

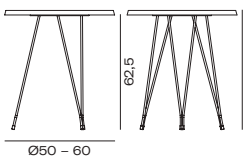

765

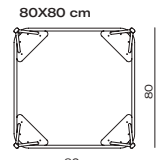
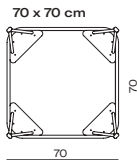

764

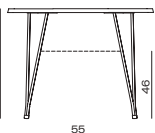
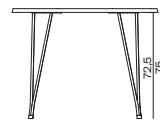
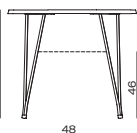
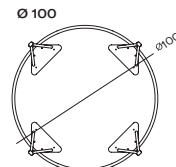
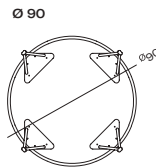
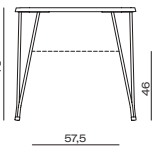
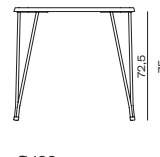
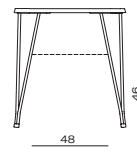
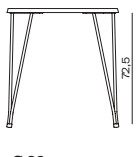
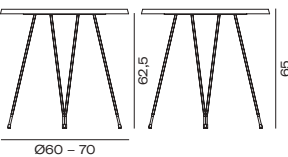

Marco del sobre / Top frame

Madera de haya, de roble y de nogal natural. / Natural beech, oak and walnut wood.



Haya / Beech
White 93

Roble natural /
Natural oak

Nogal natural /
Natural walnut

Interior del sobre / Top interior

Interior del sobre / Top interior

Acabado en madera de haya, nogal y roble. / Wooden finishes in beech, walnut or oak.



Haya / Beech
White 93

Haya / Beech
Grey 74

Haya / Beech
Grey 79

Haya / Beech
Green 66

Haya / Beech
RAL 8023

Haya / Beech
RAL 5004

Sobre Dekton / Dekton top



Zenith

Edora

Ventus

Galema

Kandum

Sirius

Sobre Silestone / Silestone top



Iconic
white

Haiku

Desert
silver

Cemento
spa

Unsui

Soapstone

Sobre Formica / Formica top

Laminado HPL. / HPL laminate.



Infiniti
F7858

Infiniti
F7923

Infiniti
F7927

Infiniti
F7961

Infiniti
F4161

Infiniti
F7966

Infiniti
F2297

Infiniti
F2253

Estructura / Frame

Acero lacado. / Lacquered steel.



RAL
1013

RAL
9003

RAL
7044

RAL
7030

RAL
7039

RAL
1000

RAL
8000

RAL
1027



RAL
8023

RAL
3012

RAL
3016

RAL
3011

RAL
6013

RAL
6006

RAL
5004

RAL
9004

Naoshima Collection by Emiliana Design

Modelos / Models

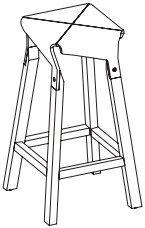

701

Asiento / Seat

Contrachapado de haya o roble, acabado madera natural, laca o tinte.
/ Beech or oak plywood, natural wood finish, lacquer or dye.

Patatas / Legs

Madera maciza de haya natural o tintada y madera maciza de roble natural o lacada. / Natural or dye beech solid wood & natural or lacquered oak solid wood.

Peso / Weight

5 kg/u

Volumen caja /

Volumetric Packaging
1 u. 42 x 42 x 87 cm



702

Asiento / Seat

Contrachapado de haya o roble, acabado madera natural, laca o tinte.
/ Beech or oak plywood, natural wood finish, lacquer or dye.

Patatas / Legs

Madera maciza de haya natural o tintada y madera maciza de roble natural o lacada. / Natural or dye beech solid wood & natural or lacquered oak solid wood.

Peso / Weight

4 kg/u

Volumen caja /

Volumetric Packaging
1 u. 42 x 42 x 87 cm



703

Asiento / Seat

Contrachapado de haya o roble, acabado madera natural, laca o tinte.
/ Beech or oak plywood, natural wood finish, lacquer or dye.

Patatas / Legs

Madera maciza de haya natural o tintada y madera maciza de roble natural o lacada. / Natural or dye beech solid wood & natural or lacquered oak solid wood.

Peso / Weight

3,5 kg/u

Volumen caja /

Volumetric Packaging
2 u. 42 x 42 x 87 cm

Premios / Awards



reddot award 2016
winner

Desde 2018, Naoshima stool forma parte del fondo de arte contemporáneo del Centre Pompidou de Paris.

Since 2018, Naoshima stool is part of the contemporary art collection of the Centre Pompidou in Paris.

Medidas / Dimensions

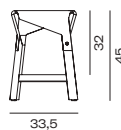
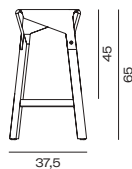
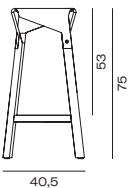

Asiento / Seat

Madera contrachapada de roble o haya. / Oak or beech veneer plywood.

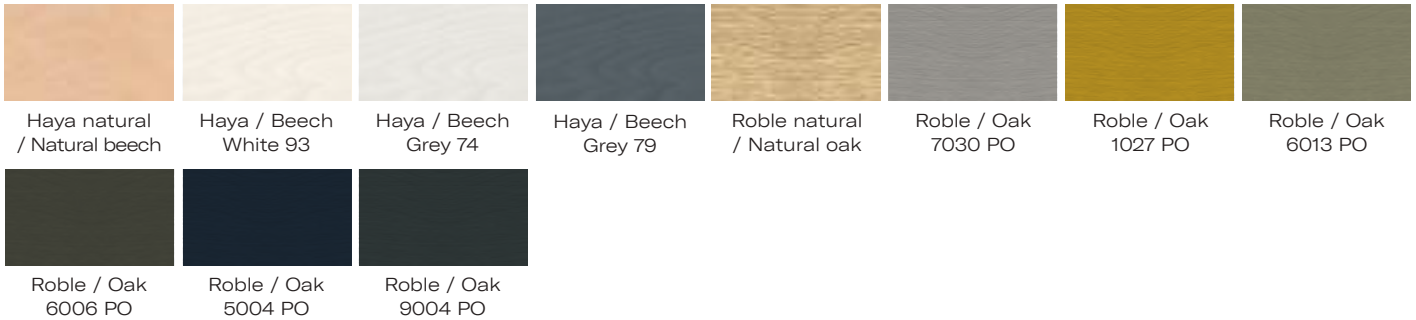

Patatas / Legs

Madera maciza de roble o haya. / Solid oak or beech wood

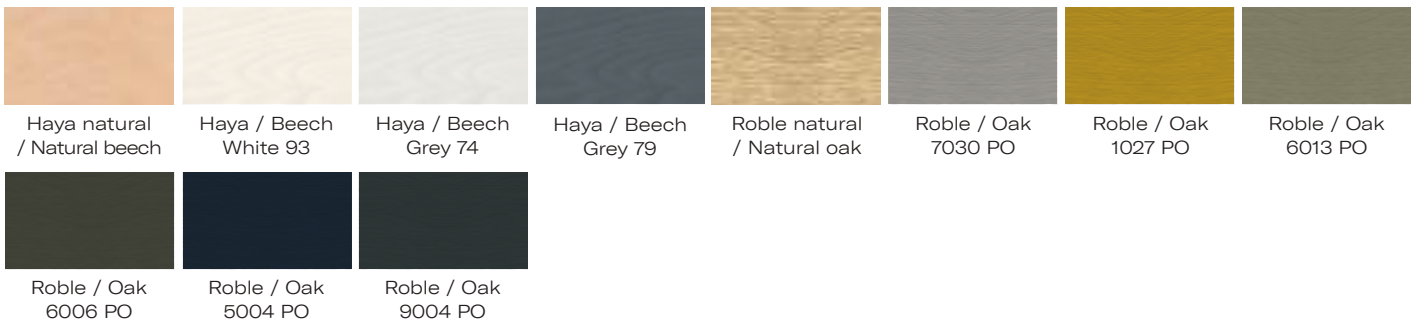

Todos los acabados que se muestran a continuación forman parte de una elaborada selección. Para ver carta completa de acabados dirigirse a pág. 184. / All finishes shown below are part of an elaborate color palette. To see the complete catalogue of finishes see page 184.

Certificados / Certificates

Modelo / Model 701. 1st Level EN 16139:2013.

Sandwich Collection by Untaller

Modelos / Models

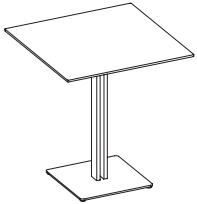

351-01

Sobre / Top

Sobre máximo
Ø 90 o 80 x 80 cm
aconsejable. / Top
recommended of
Ø 90 o 80 x 80 cm.

Estructura / Frame

Base y columnas
metálicas en acero
pintado en polvo
poliéster color RAL.
Niveladores ajustables
Opción de revestir la
columna de madera. /
Metal base and column
in steel coated with RAL
polyester powder paint.
Adjustable leveling feet
Option to cover the
column in wood.

Peso / Weight

18 kg/u

Volumen caja /

Volumetric Packaging

1 u. 45 x 45 x 110 cm



352-01

Sobre / Top

Sobre máximo
Ø 80 o 70 x 70 cm
aconsejable. / Top
recommended of
Ø 90 o 80 x 80 cm.

Estructura / Frame

Base y columnas
metálicas en acero
pintado en polvo
poliéster color RAL.
Niveladores ajustables
Opción de revestir la
columna de madera. /
Metal base and column
in steel coated with RAL
polyester powder paint.
Adjustable leveling feet
Option to cover the
column in wood.

Peso / Weight

18 kg/u

Volumen caja /

Volumetric Packaging

1 u. 45 x 45 x 110 cm

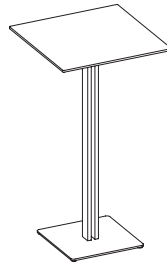

353-01

Sobre / Top

Sobre máximo
Ø 80 o 70 x 70 cm
aconsejable. / Top
recommended of
Ø 80 o 70 x 70 cm.

Estructura / Frame

Base y columnas
metálicas en acero
pintado en polvo
poliéster color RAL.
Niveladores ajustables
Opción de revestir la
columna de madera. /
Metal base and column
in steel coated with RAL
polyester powder paint.
Adjustable leveling feet
Option to cover the
column in wood.

Peso / Weight

20 kg/u

Volumen caja /

Volumetric Packaging

1 u. 45 x 45 x 110 cm

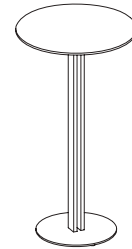

354-01

Sobre / Top

Sobre máximo
Ø 70 o 60 x 60 cm
aconsejable. / Top
recommended of
Ø 80 o 70 x 70 cm.

Estructura / Frame

Base y columnas
metálicas en acero
pintado en polvo
poliéster color RAL.
Niveladores ajustables
Opción de revestir la
columna de madera. /
Metal base and column
in steel coated with RAL
polyester powder paint.
Adjustable leveling feet
Option to cover the
column in wood.

Peso / Weight

20 kg/u

Volumen caja /

Volumetric Packaging

1 u. 45 x 45 x 110 cm

Medidas / Dimensions

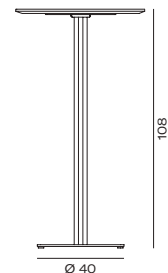
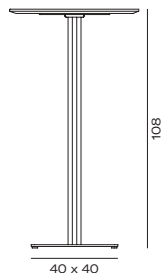
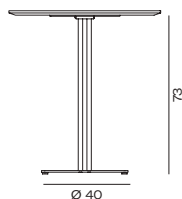
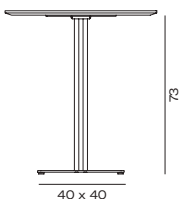

Modelos / Models

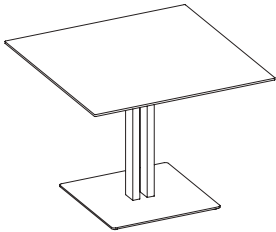

355-01

Sobre / Top

Sobre máximo
 Ø 150 o 120 x 120 cm
 aconsejable. / Top
 recommended of
 Ø 150 o 120 x 120 cm.

Estructura / Frame

Base y columnas
 metálicas en acero
 pintado en polvo
 poliéster color RAL.
 Niveladores ajustables
 Opción de revestir la
 columna de madera. /
 Metal base and column
 in steel coated with RAL
 polyester powder paint.
 Adjustable leveling feet
 Option to cover the
 column in wood.

Peso / Weight

22 kg/u

Volumen caja /

Volumetric Packaging

1 u. 65 x 65 x 80 cm

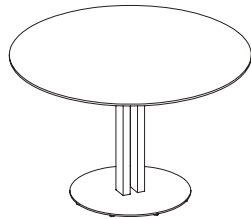

356-01

Sobre / Top

Sobre máximo
 Ø 130 o 100 x 100 cm
 aconsejable. / Top
 recommended of
 Ø 150 o 120 x 120 cm.

Estructura / Frame

Base y columnas
 metálicas en acero
 pintado en polvo
 poliéster color RAL.
 Niveladores ajustables
 Opción de revestir la
 columna de madera. /
 Metal base and column
 in steel coated with RAL
 polyester powder paint.
 Adjustable leveling feet
 Option to cover the
 column in wood.

Peso / Weight

22 kg/u

Volumen caja /

Volumetric Packaging

1 u. 65 x 65 x 80 cm

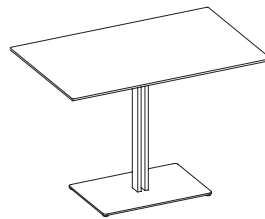

357-01

Sobre / Top

Sobre máximo
 120 x 80 cm aconsejable.
 / Top recommended of
 120 x 80 cm.

Estructura / Frame

Base y columnas
 metálicas en acero
 pintado en polvo
 poliéster color RAL.
 Niveladores ajustables
 Opción de revestir la
 columna de madera. /
 Metal base and column
 in steel coated with RAL
 polyester powder paint.
 Adjustable leveling feet
 Option to cover the
 column in wood.

Peso / Weight

24 kg/u

Volumen caja /

Volumetric Packaging

1 u. 65 x 45 x 75 cm

Medidas / Dimensions

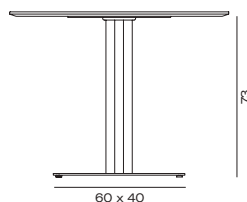
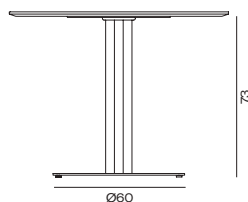
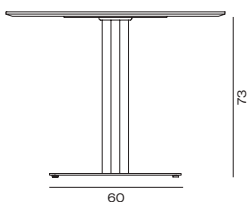

Sandwich Collection by Untaller

Modelos / Models

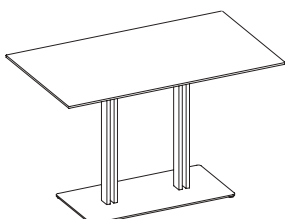

358-01

Sobre / Top

Sobre máximo
160 x 80 cm aconsejable.
/ Top recommended
of 160 x 80 cm.

Estructura / Frame

Base y columnas
metálicas en acero
pintado en polvo
poliéster color RAL.
Niveladores ajustables
Opción de revestir la
columna de madera.
/ Metal base and column
in steel coated with RAL
polyester powder paint.
Adjustable leveling feet
Option to cover the
column in wood.

Peso / Weight

35 kg/u

Volumen caja /

Volumetric Packaging

1 u. 45 x 45 x 110 cm

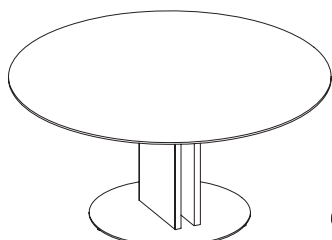

359-01

Sobre / Top

Sobre máximo Ø 180
o 150 x 150 cm
aconsejable. / Top
recommended of 180
o 150 x 150 cm.

Estructura / Frame

Base y columnas
metálicas en acero
pintado en polvo
poliéster color RAL.
Niveladores ajustables
Opción de revestir la
columna de madera. /
Metal base and column
in steel coated with RAL
polyester powder paint.
Adjustable leveling feet
Option to cover the
column in wood.

Peso / Weight

60 kg/u

Volumen caja /

Volumetric Packaging

1 u. 45 x 45 x 110 cm



977

Sobre / Top

MDF chapado de madera
de haya, fresno o
laminado de Formica
Infiniti. Acabados
disponibles en madera
natural, tinte o laca.
/ MDF veneered with
beech veneer,
ash veneer or Formica
laminated. Finishes are
available in natural wood,
dye or lacquer.

Peso / Weight

Segun medidas
y acabados. / Depending
on size & finish.

Volumen caja /

Volumetric Packaging

2u. Ø 60 o/or 60 x 60

= 62 x 62 x 2,5 cm

2 u. Ø 70 o/or 70 x 70

= 72 x 72 x 2,5 cm

2 u. Ø 80

= 82 x 82 x 2,5 cm

Medidas / Dimensions

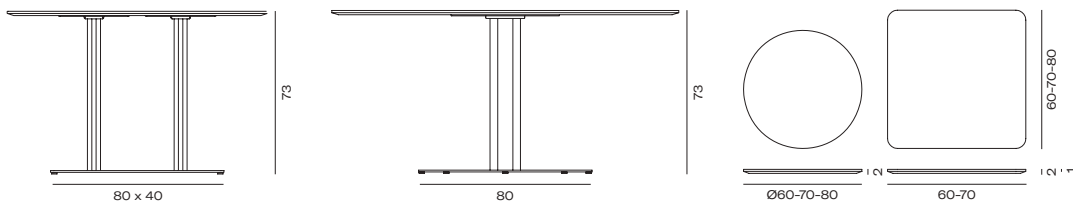

Sobre madera / Wooden Top

Rechapado de madera. / Wooden veneer.

Columna de madera / Wood colum

Madera maciza / Solid Wood.



Sobre Formica / Formica top

Laminado HPL. / HPL laminate.

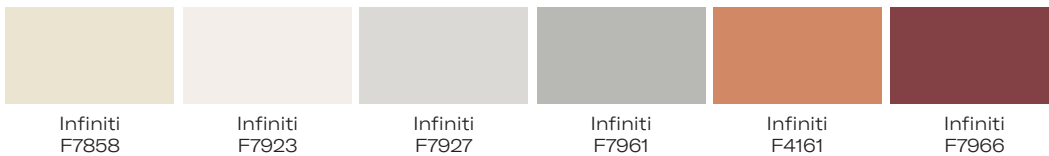

Dekton acabado mineral / Dekton mineral finishes

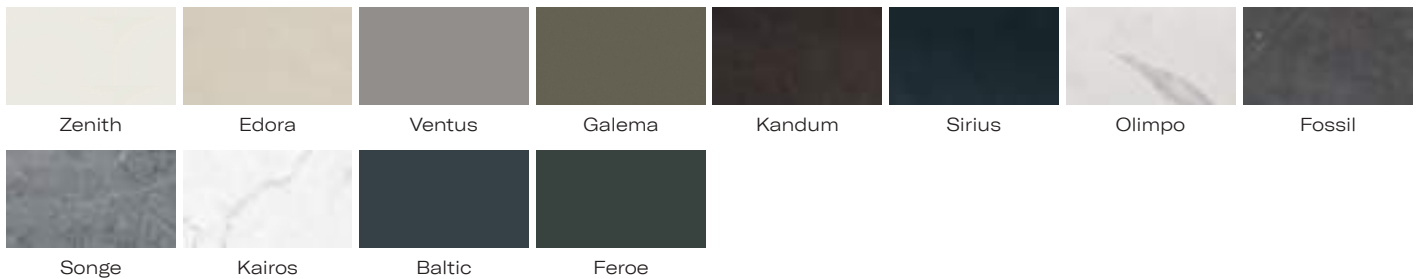

Madera de fresno y roble lacada / Lacquered ash & oak wood

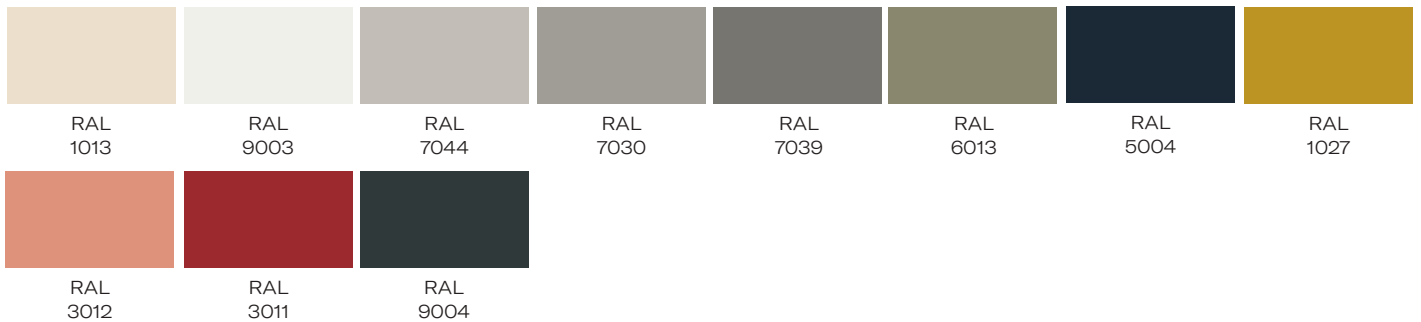

Acabados metálicos / Metal finishes

Acabados RAL / RAL finishes





















Todos los acabados que se muestran a continuación forman parte de una elaborada selección. Para ver carta completa de acabados dirigirse a pág. 184. / All finishes shown below are part of an elaborate color palette. To see the complete catalogue of finishes see page 184.

Acabados madera / Wooden finishes

Madera de fresno y roble lacada / Lacquered ash & oak wood

							
RAL 1013 PO	RAL 9003 PO	RAL 7044 PO	RAL 7030 PO	RAL 7039 PO	RAL 1000 PO	RAL 8000 PO	RAL 1027 PO
							
RAL 8023 PO	RAL 3012 PO	RAL 3016 PO	RAL 3011 PO	RAL 6013 PO	RAL 6006 PO	RAL 5004 PO	RAL 9004 PO

Madera de haya tintada / Dye beech wood

							
White 13	White 93	Grey 74	Grey 70	Grey 79	Salvia 10	Brown 80	Yellow 17
							
Orange 83	Pink 32	Red 36	Red 31	Green 63	Green 66	Blue 54	Black 94
							
Wengué / Wenge	Nogal / Walnut	Roble claro / Light oak					

Madera natural barnizada / Natural wood varnished

			
Nogal / Walnut	Haya / Beech	Fresno / Ash	Roble / Oak

Acabados metal / Metal finishes

Acero lacado / Lacquered steel



Acabados metálicos / Metal finishes

Acabados RAL / RAL finishes



Los colores y acabados referenciados en este catálogo pueden variar respecto a la realidad, para una equivalencia mas precisa consultar el muestrario general de materiales y acabados. Todos los colores de pinturas y lacs corresponden a la carta RAL. Todos nuestros productos se pueden personalizar a la medida de cada proyecto, de hostelería y colectividades, según los requerimientos de cada cliente y prescriptor. Todas las medidas están expresadas en cm, con una tolerancia de +/- 0.5.

The colours and finishes referenced in this catalogue may vary. For more precise compatibility, check our general collection of material and finish samples. All paint and lacquers are from the RAL portfolio. All our products may be customized to any hotel & restaurant project or community according to the requirements of each client and the relevant specifications. All measurements are expressed in cm with a +/- 0.5 margin.

Acabados tapizado / Upholstery finishes

Gabriel

Textil / Fabric – Note, Harmony, Mood, Fame, Go Uni, Altantic, Go Check & Select.



Spradling

Piel Vegana (PV) / Vegan leather – Dolce.



Penelopeoggi

Piel Natural / Natural leather – Nuvola.



Rattan / Cane

Este acabado es de uso exclusivo para el respaldo de la colección Bernardes.
/ This finish is exclusively for the backrest of the Bernardes collection.

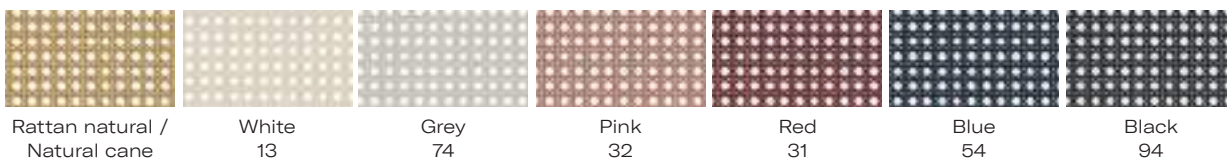

Acabados de sobres de mesas / Table top finishes

Madera de fresno y roble lacada / Lacquered ash & oak wood



Madera de haya tintada / Dye beech wood

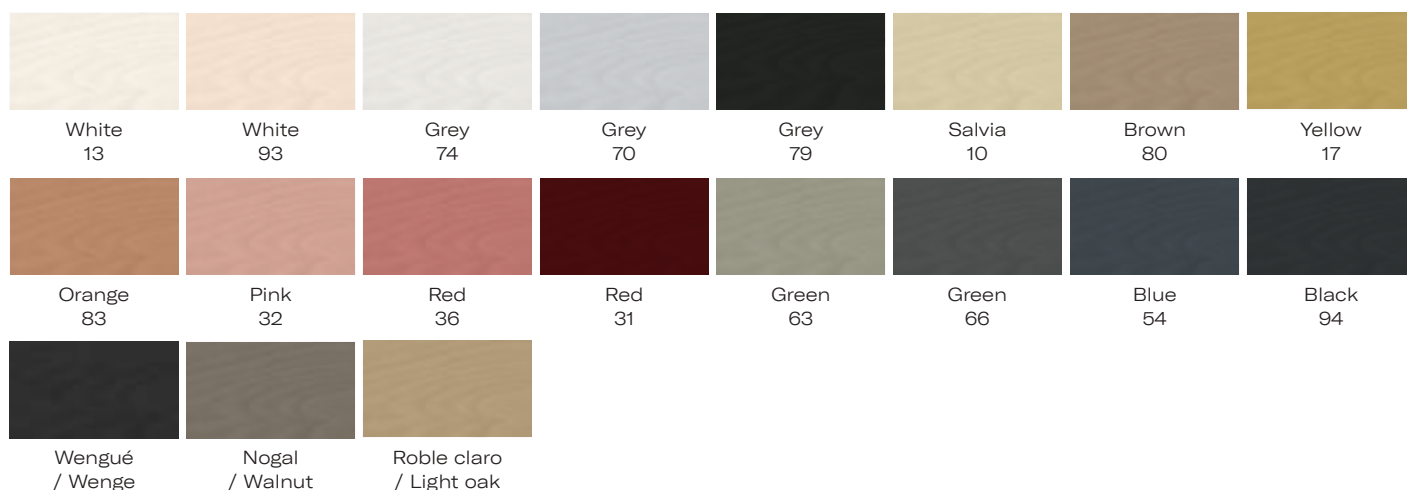

Madera natural barnizada / Natural wood varnished

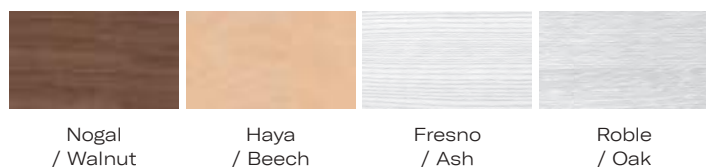

Dekton acabado mineral / Dekton mineral finishes

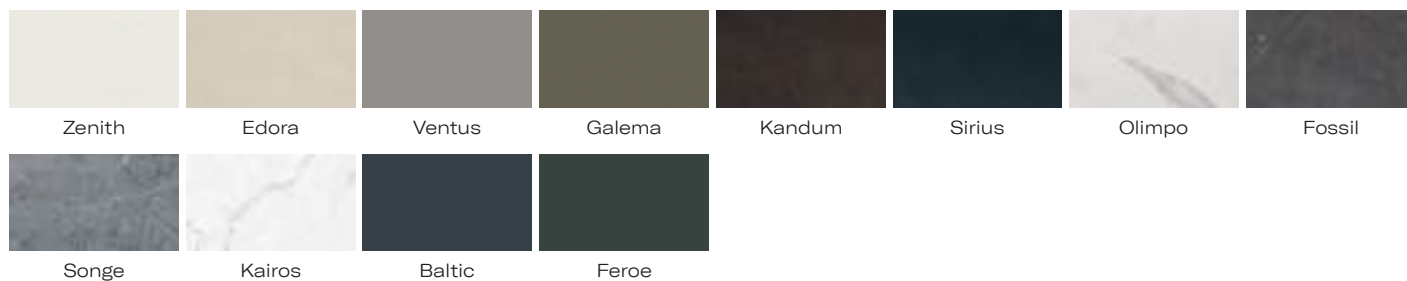

Silestone acabado mineral / Silestone mineral finishes

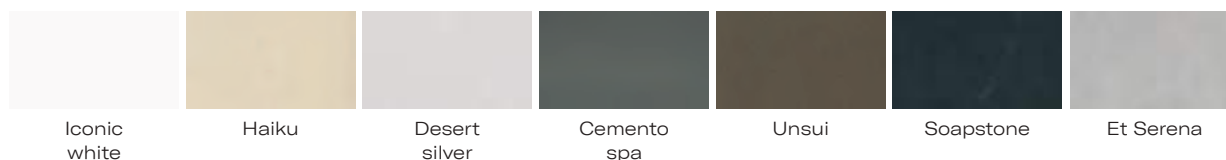

Acabados Formica / Formica finishes

Laminado HPL. / HPL laminate.

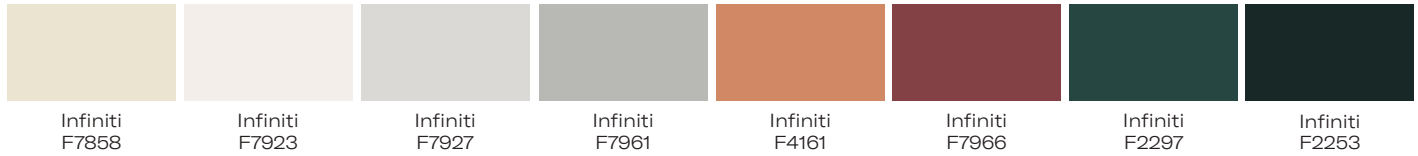

Acabados estructuras de mesas / Table frame finishes

Acero lacado / Lacquered steel

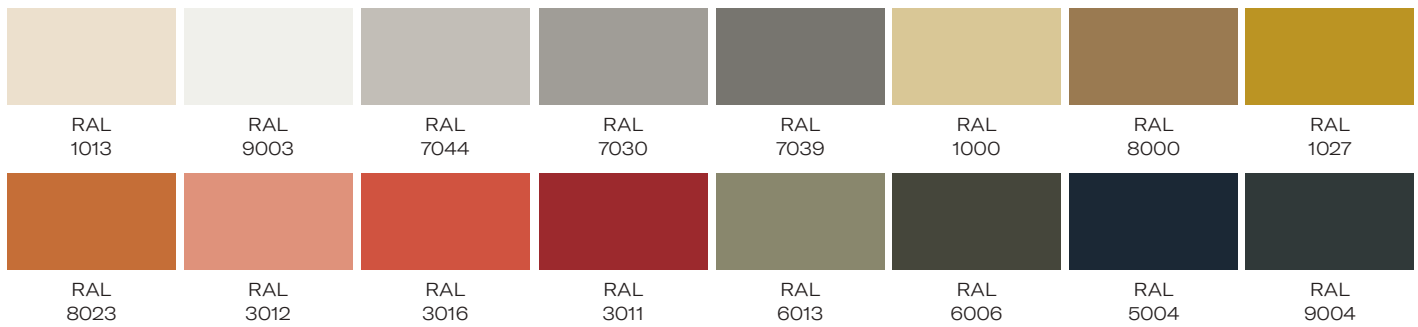

Acabados metálicos / Metal finishes

Acabados RAL / RAL finishes

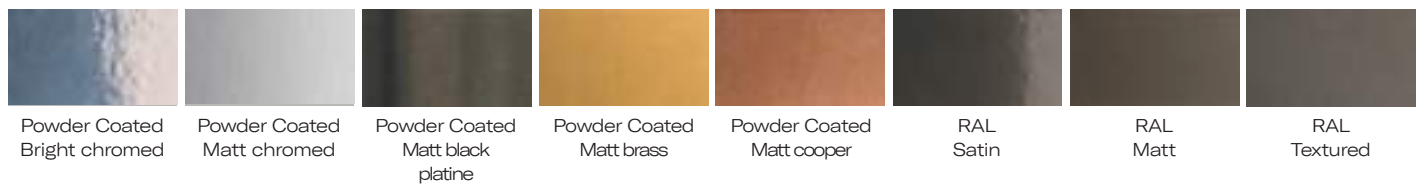

Ctra. Brunells, s/n
17853 Tortellà, Girona
T. +34 972 287 277
F. +34 972 687 635
info@verges.design
www.verges.design

Creative & Art Direction
Emiliana Design Studio

Set Design
Emiliana Design Studio

Graphic Design
P.A.R

Product photography
Francesc Rabat

Landscape photography
Esteve Serra

Prelude text
Slowkind

Thanks to:
Beatriz Furest, Cosentino, Cus,
Ekobo, Martín Azúa, Murmull
nanimarquina & Vibia.